

ROMANIA
NATIONAL DEFENCE UNIVERSITY "CAROL I"
CENTRE FOR DEFENCE AND SECURITY STRATEGIC STUDIES



STRATEGIC IMPACT

No. 4[33]/2009

68-72 Panduri Street, sector 5, Bucharest, Romania
Telephone: (021) 319.56.49; Fax: (021) 319.55.93
E-mail: cssas@unap.ro; Web address: <http://impactstrategic.unap.ro>, <http://cssas.unap.ro>

NATIONAL DEFENCE UNIVERSITY "CAROL I" PRINTING HOUSE
BUCHAREST, ROMANIA



STRATEGIC IMPACT

The Centre for Defence and Security Strategic Studies' scientific quarterly magazine acknowledged by the National University Research Council as a B+ magazine

Editorial Board>

Teodor Frunzeti, Professor, Ph.D., chairman

Marius Hanganu, Professor, Ph.D.

Constantin Moștofleu, Senior Researcher, Ph.D.

Hervé Coutau-Bégarie, director, Ph.D. (Institute for Compared Strategy, Paris, France)

John L. Clarke, Professor, Ph.D. (European Centre for Security Studies "George C. Marshall")

Adrian Gheorghe, Professor Eng., Ph.D. (Old Dominion University, Norfolk, Virginia, USA)

Libor Frank, Ph.D. (Institute for Strategic Studies, Defence University, Brno, Czech Republic)

Dario Matika, Ph.D. (Institute for Research and Development of Defence Systems, Zagreb, Croatia)

Nicolae Dolghin, Senior Researcher, Ph.D.

Gheorghe Văduva, Senior Researcher, Ph.D.

Scientific Board>

Mihai Velea, Professor, Ph.D.

Grigore Alexandrescu, Senior Researcher, Ph.D.

Editors>

Constantin Moștofleu, Senior Researcher, Ph.D., editor-in-chief

Vasile Popa, Researcher, deputy editor-in-chief

Corina Vladu

George Răduică, Ph.D.

The authors are responsible for their articles' content, respecting the provisions of the Law no. 206 from the 27th of May, 2004, regarding the conduct in scientific research.



CONTENTS

THE POLITICAL-MILITARY PRESENT

<i>New threats to security. Institutional mechanisms and counteracting capabilities</i> Gheorghe MARIN, PhD.....	5
<i>Regional cooperation in the Wider Black Sea Area</i> Georgeta GAVRILĂ	12
<i>Implications of changing the concept of establishing the US anti-missile shield in Europe on European security and transatlantic relationship</i> Teodor FRUNZETI, PhD.....	20

GEPOLITICS AND GEOSTRATEGIES ON THE FUTURE'S TRAJECTORY

<i>Regional cooperation in the Balkans and Scandinavia. Particular approach - global effects</i> Virgil BĂLĂCEANU, PhD, Adrian VOINEA.....	26
<i>Bonne gouvernance dans l'actuelle crise économique et financière</i> Petre DUȚU, PhD.....	33

NATO AND EU: POLITICS, STRATEGIES, AND ACTIONS

<i>Implementation of NATO EBAO doctrine and its effects on operational staffs' structure and functions</i> Christophe MIDAN	39
<i>Human security and the phrase "Partnership for security" for NATO's Strategic Concept</i> Paul DUȚĂ, PhD	55
<i>The EU integration of the Western Balkans states and Turkey - security costs and gains</i> Gheorghe IORDACHE, PhD, Cristina BOGZEANU	65

SECURITY AND MILITARY STRATEGY

<i>Energy security - a major strategic stake</i> Doina MUREȘAN, PhD.....	74
-----------------------------------------------------------------------------	----

ANALYSIS. SYNTHESIS. EVALUATIONS

<i>Power relations between realism and neorealism in Hans Morgenthau's and Kenneth Waltz's visions</i> Niculae TABARCIA.....	79
---------------------------------------------------------------------------------------------------------------------------------	----



STRATEGIC IMPACT

<i>The characteristics and the dynamics of the immigration flows towards Romania</i> Ionel STOICA	86
<i>A possible solution: a synergic Pontic-Mediterranean continuum</i> Grigore ALEXANDRESCU, PhD.....	97

POINT OF VIEWS

<i>The cultural differences between the military and the society</i> Grațîela VLADĂIANU	100
<i>The need for NATO's transformation. Generating factors</i> Aurelian RAȚIU	110

REVIEWS

<i>About the coup d'état and the defence against it.....</i>	119
--------------------------------------------------------------	-----

CDSSS' AGENDA

<i>The activities of the Centre for Defence and Security Strategic Studies, October-December 2009</i> Irina CUCU.....	120
<i>Instructions for authors.....</i>	121



NEW THREATS TO SECURITY. INSTITUTIONAL MECHANISMS AND COUNTERACTING CAPABILITIES

Gheorghe MARIN, PhD

Once the bipolar world dissolved, the direct threats to European states security have diminished and in result the actions counteracting the threats have become closer to their hotbed. This fact meant an increased number of missions carried out by the European states both in conflict areas and the Middle East, Asia, Africa as well as in the Western Balkans. If, until the last decade of the 21st century, traditional threats were mainly represented by territorial disputes, ethnic and cultural disagreements or resource access competition, at present, these threats not only have lost their relevance but others have risen, too, such as terrorism, proliferation of weapons of mass destruction, existence of non-state actors, asymmetrical threats, violation of human rights, failed states or piracy as a form of organized crime.

Keywords: threats, challenges, international organizations, regional security, global security.

1. General context

For the next decades, globalization will speed up and become a driving force for the society. This will increase the states' interdependence by creating at the same time economic and cultural differences that can generate adverse reactions to globalization. In the Western democracies, the decrease of the labour market, population ageing and migration will lead to profound social transformations. The joint effects of cultural tensions, social exclusion and potential risks that will affect the day-to-day life can destabilize political systems and state authority. In the developing countries, social, economic, demographic and environmental issues can deteriorate due to the incapacity of the leading elite to solve the problems. The state will continue to represent the main actor in international relations. Nevertheless, non-state actors will have an increased role on the world stage, while the terrorist groups

and organized crime are going to consolidate, representing a strong threat to the society and citizens security. Globalization introduces a new unprecedented strategic environment in terms of complexity. This will allow local risks and threats to become global.

The world we are living in faces increasing problems due to demographic aspects. European states' internal balance is profoundly affected by the ageing population, concurrently with the migration pressure, having an impact on national identity. This trend will affect European nations' capacity to take actions outside their borders and this will reduce their determination to assume responsibilities at global level. With an old population, Europe will try to attract a young labour force. The European area concentrates 6% of the global population. This area will know a demographic increase of 2% in the next 20 years on the whole, but due to the ageing tendency of the population (some countries will face negative demographic rates – Germany, Spain, Italy) it is more difficult to be protected. Regarding this issue, on medium and long term, competition (in conjunction with ageing) and financial situation will be the real challenges. Spreading a fearful attitude to globalization represents a favourable environment to populism and economic protectionism that can affect negatively EU integration and enlargement. There are states with a high potential of trouble and tensions at the Union's borders.

Demography, climate changes, economic growth and implicitly the resources demand have led to an increase of global competition. Globalization brought great economic, social, political and education changes. At the same time, globalization generated the threats spreading, increasingly present in a permanently changing society. Which are our present capabilities and strategies to face the threats of a more and more insecure world? In order to answer this question,



it is necessary to understand the trends, threats and challenges in a global context.

European homeland security. It is unlikely to see a massive military attack against a European state. The Eastern European area can represent a region of instability, especially in the context of European Union enlargement. The main threats to citizens' security will be in particular terrorism, organized crime and maybe epidemics. The worst scenario is the possibility for the organized crime to infiltrate in the public services and political life.

The instability of the surrounding regions will influence directly or indirectly the European interests. Most problems in the neighbourhood should be treated through civilian means (diplomatic, economic, technical, etc.). In order to avoid the conflicts spreading in the neighbouring countries, EU can also use military capabilities for intervention.

Energy supply. On medium term, OPEC countries, Russia and Norway will be the main energy suppliers for the European states. To overstep the deadlock of the energy supply we need to adopt both technological measures (to reduce consumption) and political ones (to project the regional stability). Although there is a reduced probability, the military option (with the participation of one or more of the member states) to provide energy from a conflict area is not excluded. At present, there are states that can use energy resources and financial instruments as deterring elements in relation with other states. The non-military deterring means represent a new side that wasn't taken into consideration by the traditional military thinking.

Failed states can be "safe havens for terrorism, organized crime and other illicit activities". International community should be prepared to intercede with these regions to avoid greater damages.

The increasing power of *non-state actors*. Fanatic behaviour could lead to "terrorist attacks with radiological weapons" or other non-conventional means. The cyber attack in Estonia demonstrated that an aggression against another country shouldn't imply the use of military force.

Climate changes. This will have security implications and will intensify the competition for resources, especially for water and this way generating territorial disputes and the acceleration

of migration phenomenon which in turn will make fragile states even more instable. The climate changes and the connected issues on the environment pollution will have an increasing impact on the causes of future conflicts.

2. New security threats and challenges

Western democracies face a complexity of specific threats, multiple and interdependent. Taking into account that they can be materialized with means that are concurrently non-military (such as the cyber attacks) there are many situations when the reaction is based on other instruments than the military ones.

Conventional armaments and explosive devices will continue to be the most used tools in **terrorist attacks**. Nevertheless, as a result of access to relevant technological knowledge and an increase ability to work with CBRN materials, the terrorist groups are determined to develop and use such means. Terrorists will continue to be motivated to develop spectacular attacks, being driven by the wish to get the highest media exposure for their cause. The freedom of movement, the easy access to modern communication means allow the radical groups to recruit new members, extremist ideologies proliferation, significant resources management, as well as public opinion manipulation through media.

Cyberspace. Modern economies have significant critical infrastructure, including transport, communication, food and supply networks, and internet links. The attacks against private IT or government IT networks came with a new dimension for the conflict spectrum, and the cyber environment has become a potential new weapon for the economic, political and military fields. Moreover, the increasing connectivity of the information, Internet and other infrastructures systems provide opportunities to the attackers to disturb telecommunication, electric power, energy pipelines, financial networks, refineries as well as other critical infrastructures.

Energy security and energy policies are the responsibilities of each sovereign country. The European Union is now the main actor that promotes the development of a common energy policy focused also on reducing the carbon emissions, efficiency and bio fuels subvention, as well as a diversity of energy sources. Nevertheless, there is



no discussion about energy sources and transport means protection. In this context, energy security will need a deeper transatlantic cooperation and coordination, and NATO might play a significant role in this field. Industrialization acceleration in the last decades has led to an increase of global competition for energy resources especially for fossil fuels that allowed the suppliers to abuse of their dominant position in the world. Other alternative energy sources such as the bio fuels, liquefied coal, technologies based on hydrogen and Aeolian energy should be encouraged. Although investments and researches in the alternative energies sources (technologies based on hydrogen and different bio fuels) are expected to increase and be encouraged, their implementation on a large scale is still very expensive. Rare and essential mineral resources do not represent an advantage for the local populations and there is the risk for them to become a source of political instability (Congo, Nigeria, Sierra Leone, Caucasus region). Therefore, the energy security risks are expected to remain more sensitive for Europe and Asia than for America. The dependency on oil and natural gas is a vulnerability that some governments will try to exploit.

The **asymmetric threats** could largely vary from military direct actions against national territory to the abroad ones. The asymmetric threat sources – such as insurgents - are related to the international crime sophisticated networks. It is important to be aware of the fact that such a threat could be a combination of economic, military and terrorist factors. All these threats and challenges could be even higher when considering the more democratic a state is, the more likely it is to fully observe conventions and international laws, while “the other side” do not have such ethics, and thus creating a discrepancy during an ongoing conflict.

The increased energy consume will implacably lead do a **considerable increased use of nuclear energy for non-military applications**. Although the economic and environmental reasons facilitate such an approach, this tends to result into major security risks. The temptation of enriching uranium beyond its civil applications (and thus obtaining secondary products – plutonium) concludes in undermining Nuclear Arms Non-proliferation Treaty. Therefore a decisive control by entitled international organizations and agencies’ (e.g. International Agency for Nuclear Energy) and

regular verifications will be highly important. In case the international community fails to find a solution to nuclear ambitions of those states or regimes placed beyond the democratic control, the proliferation of weapons of mass destruction (WMD) will be also out of control. WMD is a major strategic threat not only for neighbouring countries but also for the region as a whole and both Europe and America as continents. It is worth to mention that achieving nuclear ambitions of whatever state does not contribute to regional stability (by the means of a mutual discouragement) but new risks and incertitude could be generated.

WMD proliferation and control is strictly controlled by several treaties and ad-hoc arrangements (Convention on biological and chemical armaments, Missiles Technologies Control Regime, etc). However, WMD proliferation is closely related to the proliferation of dual-use technologies that remains one of the higher risky security threats for the next decades. An efficient approach of this type of threats will imperatively require a closer cooperation among states and international security organizations and a comprehensive global approach involving the international community, too.

Currently, the international trade is 90% based on maritime transportation routes. Piracy represents the major threat to transport routes, as a new dimension of organized crime. Piracy in the Indian Ocean and Gulf of Aden is also affecting delivery of humanitarian aid to Somalia and that brings on immediate response countermeasure from the international community, as NATO and EU have conducted two naval operations in the region namely Ocean Shield and Atalanta.

By its character and applicability domain, the **current worldwide economic and financial crisis** is perceived as an exception whose long- term effects are hardly predictable. The financial crisis and global recession are susceptible of bringing to the fore huge economic crises in the under developed countries. Since 2003, some security implications caused by climate changes have been revealed. Natural disasters, environmental damages and tough competition for resources, are all conflict generators especially under extreme poverty conditions when refer to people in need. Climatic changes could also bring about severe disputes on commercial routes of access to resources sites, otherwise inaccessible before.



3. The role played by international organizations in strengthening regional and global security

A realistic while accurate assessment of regional cooperation interdependence aspects should be a first step and a prerequisite, prior to evaluate the capabilities required for countering the new asymmetric threats.

As already mentioned, the specific trends, particular risks and threats could not be separately addressed or in a self-contained manner. Albeit a problem may have geographical limits, a viable risk assessment should have globally effects. It is deemed necessary to carefully evaluate the present challenges' complexity and their interconnectivity. This is a particular feature of globalization definitely characterized by multiple and multi-directional threats. It implicitly requires a comprehensive approach meant to facilitate a strategic response according to the security environment complexity we are facing with. We are currently witnessing an even increasing role of non-military means in combating the present threats.

These threats require a sustained preparation aimed at developing flexible response kits for better countering of unforeseeable risks and threats. We are fully aware that no nation could address these challenges alone but as partners of security alliances such as NATO, the best organized and equipped structure able to confront new threats.

We shall try to answer the question whether, nowadays, the international and regional security organizations are able to properly respond to the new threats and they do have the right capabilities as required under current circumstances. Starting from an overview on recent conflicts wherever the world they might occur, the need for closer cooperation of security organizations becomes pregnant; at the same time, it should attend upon development of a culture focused on an integrated while joint response to the actual threats.

The United Nations Organization (UN) should play a crucial role in combating global security threats. Notwithstanding the UN avails of great capabilities there are also important limitations mainly caused by the lack of an efficient strategy for implementing its major aim: preserving global security and preventing the genocide. At the same time, there are many regional organizations as established according to Chapter VIII of the UN

Charter: African Union, Association of South-Eastern Asia Nations (ASEAN), American States Organization, Shanghai Cooperation Organization, etc. Further on, all these organizations intend to play a more important role in conflict prevention and crisis management. However they are facing severe caveats in terms of unity, executive power and, the last but not the least, the capabilities.

Organization for Security and Cooperation in Europe (OSCE) is a regional organization of great impact on security issues. OSCE avails of peaceful means for conflict settlement as early warning in case of human rights violations or ethnic disputes thus getting often involved in peace-building or monitoring actions. In spite of these, OSCE does not have enough capabilities for restoring peace and security under crisis. It also fails of a comprehensive vision and a common strategy.

The European Union (EU) is an exclusive international organization, transnational fractionally and a confederation in some respects. The recently passed Lisbon Treaty is to permit the EU a coherent approach of Common Security Policy - related issues mainly in terms of financial and economic resources highly important for implementing the European Security Strategy.

The North Atlantic Treaty Organization (NATO) is the most successful political and military alliance of our recent history which has succeeded in shifting disputes' settlement from confrontation to cooperation in Europe. The Alliance is now defining future courses of action including a new strategic concept.

4. Counteracting capabilities

The actual security risks and threats very present in the globalization era should not make us ignore the pessimistic scenarios and to lessen the future conflicts' duration as well as the very substance of required engagements. Therefore, persistence is a key element depending not only on the political will but also on military and non-military capabilities to be further involved, as required.

The majority of European states are not fixed for adequate military capabilities to face with new security threats. In this context, either at the Alliance's level there are not enough non-military capabilities able to effectively confront such



situations. Moreover, a recent study elaborated by Centre for International and Strategic Studies emphasizes that when refer to C4ISR capabilities (command, control, communications, computers, information, survey and reconnaissance) there is a gap between the US system and the European ones. The authors noted that this gap is not because of technologies scarcity but it is rather due to some budgetary constraints of European states, as C4ISR is still a domain requiring a transatlantic cooperation for increasing interoperability at both transatlantic level and intra-European level. To overcome these difficulties, the authors recommend a better coordination and integration of defence endeavours so that European countries could create their own collective defence capabilities (supported by NATO and EU). Measures meant to implement this requirement should envisage a wider cooperation in the field of research and technology, a common pool of national contributions while developing some niche capabilities. The very nature of future operations will underline the multinational expeditionary forces' ability of commonly operating in quite demanding geographical and climatic operation areas. In the context, it will be preserved the capacity of conducting the whole range of peace operations from collective defence high intensity operations up to stabilization and reconstruction at a large scale operations.

The future risks and threats will require the Alliance's ability to achieve a strategic unity for maintaining solidarity in the context of Article 5 type missions. In order to prepare its forces for efficiently facing new challenges, the Alliance should employ highly improved training methods and techniques capable of rapidly simulating the various conditions of any potential battlefield.

The Alliance transformation process needs to be supported by its member states' Armed Forces transformation. In case the major security threats are currently exceeding Europe territories and if agreed on considering these problems as they occur, then we have to admit that new military capabilities different from those appealed to during the Cold War are imperatively requested. There is a need for robust, more flexible and rapid deployable expeditionary forces and on a long-term self sustainable. This is concomitantly achieved while adapting command and control structures including rapid deployable capabilities in a comprehensive approach which would

integrate some other international organizations and agencies' personnel for further engagement in non-combat type missions (humanitarian assistance, maritime security, protection of critical infrastructure and non-proliferation operations).

NATO accrued significant progress on developing modern military capabilities. In this respect, NATO Response Force (NRF) is one of the most important achievements as providing a new rapid reaction capability to the Alliance. Strategic transport capabilities have also been substantially improved.

Defending citizens, territory, interests, culture and liberty of the Western states is done by participation in missions in different theatres of operation, most of the time outside national territory. Therefore, current operations are of an expeditionary nature, totally different from those conducted during the Cold War, when they were of a static type, related to defence of the territory. The main characteristics of current operations are: deployment in the theatre must be conducted in short time; the established objectives are often limited being marked by shortfalls; very often crisis management operations are long missions; a high level of interoperability is needed because forces must operate jointly; the need to establish a rapid reaction force; forces deployed must be sustainable for a long period of time, according to assumed engagements; forces must be trained and equipped so as to be able to meet the entire range of missions. As a consequence, during the last decade, essential changes occurred in doctrines and training procedures, forces' organization and acquisitions (new types of equipment and materials) at the level of Euro-Atlantic organizations and member states. At the same time, studies related to usability were initiated. In addition to this, we may say that military operations of the last decade demonstrated the importance of a number of factors, the most significant of which are *interoperability and training*.

Even though NATO member states are investing in new military capabilities (conceived for defence of NATO states territory), there are few situations when they can respond to new types of threats. This demonstrates the reticence of European nations when it comes to large investments in defence area.

Intelligence. If threats during the Cold War were concentrated at regional level, and at a



certain degree their evolution could be forecasted, the proliferation of weapons of mass destruction and terrorism demonstrated inefficiency of democratic states in countering them. 9/11 events showed the need to cooperate and exchange information between specialized agencies, nations, international organizations, as well as partners with the purpose of timely meeting these threats, the need to develop Joint Intelligence Surveillance and Reconnaissance structures, to consolidate network capabilities so as nations could conduct a timely information exchange.

Durability in combating new types of threats is a major problem and has an effect not only on the military component (personnel, equipment, and logistics) but has also in view political will and society's support. If we think about Bosnia, Kosovo, Iraq and Afghanistan it is obvious that they need long term engagements.

Complexity of current operations led to an increase of interaction between NATO and other international actors, creating opportunities for the extension of NATO's role in consolidating security and stability outside traditional engagement areas. More and more, NATO will be responsible for planning and conducting operations together with other international actors. Due to these characteristics, future operations will highlight even more the importance of multinational and expeditionary capabilities.

Concepts and doctrines must adapt to new requirements, which are determined by the fast tempo of the changes in the operational environment. In this respect, we have to take into account consolidation and if necessary developing of offensive and defensive concepts, of strategies and associated legal aspects, so as to discourage and counter threats represented by weak countries. At the same time, a special attention is given to sensitive areas, such as virtual space maritime and information space. It is also necessary to develop a culture for coherently shaping capabilities and adapting leaders for asymmetric conflicts or hybrid threats.

5. Specific aspects, actions taken at national level

The Romanian Armed Forces must face these threats, fact that led to the initiation of an ample transformation process, in the framework of which

General Staff played and continues to play a key role.

NATO membership imposed initially the generation of a reform and restructuring process of the entire military body, an ample and complex process which was conceived, planned and coordinated by General Staff. The transformation process of the Romanian Armed Forces was and is associated with NATO transformation where NATO requirements concerning manning, high costs for sustaining troops in theatres, significant differences between technologies and equipment in the Alliance's advanced countries are conditions in the transformation process. In this respect, General Staff represents the engine of this process, having an essential role to play in transforming the Armed Forces from a huge and heavy structure, with responsibilities, which were strictly territorial, into modern well equipped and trained Armed Forces, which would participate in ensuring security and integrity of the national territory. This would allow the conduct of operations on national territory, in NATO's area of responsibility, as well as in a more extended strategic environment, permanently influenced by factors that impose the change.

We have also focused on planning and developing military capabilities which would ensure operational effect demanded by specific standards in a certain environment for a certain period of time their efficiency being tied to the synergy resulted from the way in which they are joined and implemented in a defined environment (interoperability).

Therefore, while developing capabilities and for fulfilling assumed engagements to NATO and EU we have in view the following domains:

- *new Command Control Communications, computers, information, surveillance and reconnaissance Concept implementation*
- *capabilities* for ensuring the information and research at operational and strategic level;
- *manoeuvre capabilities* through increase of force deployment capacity, covering the needs for strategic airlift;
- *efficient engagement capabilities* through major procurement programs, which would ensure participation in multinational operations in urban environment of high-tech individual combat systems.

Planning for developing military capabilities, at national level, is a central function of the



THE POLITICAL-MILITARY PRESENT

strategic planning, which is conducted, based on an algorithm and comprises: identifying trends in the security environment; establishing trends in military technology evolution; establishing a general military level of ambition; determining military capabilities needs; evaluating existent capabilities and possible shortfalls; identifying ways of solving these problems, meaning possible creation of new military capabilities.

We will also have to identify the elements that are not enough developed, for every capability and to correct this shortfall. Not only is the creation of certain capability difficult but also maintaining it at the established standards, especially when allotted resources are scarce.

Maintaining the units that are turned into operational certified and affirmed at NATO, at the level of accepted standards, will have to be a priority for all structures involved in this process, in which research and development plays an essential role for concentrating efforts on creating a minimum of capabilities, necessary for fulfilling the assumed international engagements.

That's why during this period and the subsequent one, this activity should be intensified, especially by participating in the initiatives to develop the capacities that are still in project stage, both nationally and within NATO and EU, or with other partners, on a bilateral base.

From this perspective, the development of the activities specific to the capacities' development process will concentrate on the following elements: training, doctrine, organization/structure, personnel, equipment, operational level and deployment capacity; financial planning of resources necessary to carry out the capacities development programmes and efforts concentration on key domains at national level (financial efforts distribution, common experience share and interoperability achievement, establish priorities of the participation in common projects at NATO and EU level).

The adjustment of the Romanian's Armed Forces to the continuous changes of the security environment is a constant process that will allow us to react efficiently and competently to the new global and regional threats to security.

Admiral professor Gheorghe MARIN, PhD (sefsmg@unap.ro), is the Chief of the General Staff. He published books, manuals, specialty treaties, especially in the Military Management and Computer Programming field as well as articles in specialty magazines from Romania and abroad.



REGIONAL COOPERATION IN THE WIDER BLACK SEA AREA

Georgeta GAVRILĂ

The destructuring of the world bipolar order has generated intense processes of searching for solutions for the new geopolitical reality. Being in a region of generous perspectives, the states within the Wider Black Sea area got involved in achieving cooperation structures meant to improve the bilateral relationships between them and also to create regional cooperation frameworks. These structures focused mainly on the economic and military fields and led to a multitude of organizations with the purpose of economically develop the states in the Black Sea area and the general security climate in this region.

Keywords: regional cooperation, cooperation initiatives, the Wider Black Sea Area.

1. Cooperation initiatives of the states within the Wider Black Sea area

Achieving the security and stability in the Wider Black Sea area has gradually become a main interest of each country in this region. The state institutions and nongovernmental organizations had to seek and propose own solutions to achieve these interests by capitalizing the regional specific similarities and by cultivating cooperation and mutual solidarity. The negotiations haven't been finalized yet but most of them display their values¹.

Over 36 bilateral treaties have been signed during the last decade between the states in the area. Beyond the formal NATO, EU and OSCE formal regulations, numerous multilateral regional initiatives have been launched; they can contribute to the development of an efficient security network for early warning and conflict prevention: Organization of the Black Sea Economic Cooperation (BSEC), BLACKSEAFOR, the Stability Pact for South Eastern Europe, the South Eastern Europe Initiative, SEEBRIG, South Eastern Europe Ministries meeting, GUAM, Black Sea Harmony, Black Sea Forum.

1.1. The military maritime cooperation of the states within the Black Sea area

The security environment challenges in the Black Sea area are caused by the ethnic conflicts and territorial secessionism with all the interests around them. To these, there are added the globalization effects on the Black Sea region, manifested by the constant increase of maritime transport volume and traffic within its communication corridor, which affects the security of the maritime domain in the region.

The data exchange within BBCIC (Black Sea Border Coordination and Information Centre) in Burgas (Bulgaria), established in 2003, by the coast guard of the six riparian countries, provides important information about the illegal activities in the Black Sea area².

The naval cooperation between the riparian states is the subject of the Document regarding the increase of trust and security, in place since 2003. This document makes explicit references to the cooperation in the field of terrorism prevention and also provisions for assistance in the fight against organized crime and illegal drug and weapon trafficking. The document, signed on April 25th 2002, regarding the measures to increase trust and security in the naval domain in the Black Sea, is a robust tool creating a solid base for the regional efforts in this direction. This document stipulates both the naval cooperation and contacts at different levels, invitations to naval bases, exchange of information and annual exercises in order to increase mutual trust³.

The military naval cooperation in the Black Sea region is represented by the BLACKSEAFOR and Black Sea Harmony initiatives.

The Black Sea Naval Cooperation Task Group (BLACKSEAFOR) encompasses the six riparian states in the Black Sea area and was established in April 2001, prior to the 9/11 attacks in the USA and started from the idea of a cooperation of the naval forces in the area in a legal framework



with a diplomatic character. The missions within this initiative meant to increase the trust, understanding and dialog between partner states. Starting August 2001, they agreed upon annual 30-day maritime exercises. Following the Planning Group in November 2005, it was decided that the BLACKSEAFOR ships be stationed in their permanent bases and be active for common training between two and four weeks twice a year.

The BLACKSEAFOR main missions are: search and rescue sea operations, humanitarian assistance operations, actions against sea mines, environment protection, courtesy visits, etc., established by all parties⁴.

The general objectives of BLACKSEAFOR activities are: promoting cooperation and interoperability between the Military Navies of the participant countries, assessing and experimenting naval procedures during peacekeeping operations.

In March 2004, Turkey, wishing to increase cooperation, establishes a new naval cooperation structure, Black Sea Harmony, with objectives similar to those ones of the NATO Active Endeavor operation in the Mediterranean Sea: establish a maritime presence along the naval communication lines and follow the suspect ships. A strong motive for establishing this structure was counteracting Romania's and Bulgaria's intentions, as NATO member states, to expand the Active Endeavor operation from the Mediterranean Sea to the Black Sea. The Turkish authorities are very determined to keep the Black Sea status quo established by the Montreux Convention provisions of maritime space with restricted access. However, Turkey launched an invitation for the riparian states to join the Black Sea Harmony operation⁵.

Ukraine and Russia joined the initiative in 2007. The following summer, in Istanbul, president Traian Băsescu stated that "Romania has already started the procedure to adopt the legislation permitting it to join the Black Sea Harmony project initiated by Turkey"⁶. Regarding the wish of other two riparian states, Bulgaria and Georgia, to join this operation, Georgia may have some difficulties because of Russia's possible opposition following the conflict in August 2008 and also Georgia's failure to recognize the new political realities.

The Black Sea Harmony mission consists in:

- *periodical maritime surveillance operations in the naval and air legal areas in accordance with the international laws;*

- *reconnaissance operations to identify suspect ships;*

- *suspect ships surveillance;*

- *naval forces' presence along the commercial ships' traffic routes*⁷.

This operation is in accordance with the UN Charter principles and the objectives established by the UN Security Council 1373, 1540 and 1566 resolutions.

1.2. Economic cooperation in the Black Sea region

Besides the EU cooperation initiative for the Black Sea region, initiative called the Black Sea Synergy and within the European Neighborhood Policy, several regional initiatives were achieved. Their purpose is to ensure the economic development of the states in the region as a mandatory condition for the improvement of the security in the area.

The most important economic cooperation initiatives are: the Black Sea Economic Cooperation Organization, Black Sea Forum for Dialogue and Partnership, the South Eastern Europe Initiative.

The Black Sea Economic Cooperation Organization (BSEC) was created in 1992 in order to promote cooperation in the fields of economy, transport, energy and environment. BSEC includes the other six riparian states – Russia, Ukraine, Turkey, Georgia, Romania and Bulgaria – and also Albania, Armenia, Moldova, Azerbaijan, Greece, Serbia and Montenegro. In 1998, a task force was established in order to fight against criminalities and manage natural disasters. In 2002, BSEC established task forces to deal with border control, crises management and antiterrorism and at the beginning of December 2004, the member states ministers of interior decided to create a network of liaison offices. BSEC also has a forum for the 13 member states ministers of foreign affairs to discuss security matters. In 2005, the USA asked for and acquired the observer status at BSEC⁸.

BSEC is structured on several cooperation dimensions: governmental, parliamentary, business, financial, banking, and scientific. The Black Sea Trade and Development Bank was established in 1999 and the Project Development Fund in 2004, as specific tools to support cooperation projects in important fields for the member states⁹.

The initial plan which, in the BSEC Economic Agenda stipulated the creation of a free trade area,



proved to be unrealistic and received a limited political support. The diversity of international engagements and the adherence of several BSEC member states to the EU laws and rules made the idea of a unitary regional economic regime become an almost impossible task. The second main goal, that to create process of cooperation based on business interests, couldn't be accomplished due to the fact that the private sector was not mentioned in the organization's decision process.

In time, the organization's activities have encompassed fields that weren't mentioned in the original concept. For instance, the *Economic Agenda for the future* includes references to governing, institutional reform and renewal. Another subject refers to the contribution to consolidate security and stability in the region, achieved mainly through a constructive involvement in other "soft" security problems (for example, organized crime, terrorism, drug and human trafficking, illegal immigration, etc). Some of the regions in the Black Sea area still have serious security problems, especially "frozen conflicts" and non-conventional threats. Before the constructive regionalism becomes a reality, these security dilemmas must be approached in a more effective manner.

Cooperation in emergency situations has become another issue referring to the concern for "soft" security, but the member states haven't yet manifested a proactive attitude towards this problem¹⁰.

For the Black Sea regionalism it's vital for BSEC to develop a constructive and structured relationship with other regional and international actors – especially with the EU which possesses both the resources and the expertise to get involved in regional projects. By transforming BSEC into a credible partner, with a clear strategy, the concept of Black Sea regionalism will be given a new meaning in a united and democratic Europe. In fact, the relationship with the EU and other European organizations have become a central element of BSEC agenda together with a financial tool separately consolidated which has been included in the new financial project for 2007-2013. In this context, a new "*Cooperation Platform between the EU and BSEC*" is expected and also defining its own role as a regional partner¹¹.

The Black Sea Forum for Dialogue and Partnership is a Romanian initiative meant to provide a transparent dialogue favourable for

launching a reflection process on the region's future and identity which should increase mutual trust, facilitate the identification of pragmatic projects capable to answer the real needs of regional development¹². In 2006, the first reunion under the aegis of the Black Sea Forum for Dialogue was organised in Bucharest.

The Forum will facilitate the identification of the convergence points between the investment projects, scientific research, regional initiatives and political processes through a series of regular or ad-hoc activities, in different formats. This will help the Black Sea countries to anticipate and solve out the potential problems quickly and effectively before they become sources of instability and threats to the regional security¹³.

The South East European Cooperative Initiative (SECI) was launched in December 1996, following the Dayton peace agreements, at the joint proposal of the EU and US with the purpose of developing a viable economic and environmental strategy in the region¹⁴.

According to the Declaration of intention regarding the cooperation within SECI, this is a regional structure which encourages the cooperation between the participants and facilitates their integration in the European structures. SECI focuses on coordinating the regional development plans, ensuring a better presence of the private sector in the economy in the area and stimulating the know-how transfer and also making investments in the private sector¹⁵.

The states participating to SECI are: Albania, Bosnia and Herzegovina, Bulgaria, Croatia, Greece, Macedonia, Moldova, Romania, Slovenia, Turkey and Hungary. The supporting countries are: Austria, Italy, Switzerland, USA, the Czech Republic and the Russian Federation.

SECI focused mainly on projects regarding the borders and the development of the transport infrastructure, security, energy and the private sector:

- *facilitating the free passage across the borders – improving the physical infrastructure, facilitating trade, achieving border information management systems, revising the visa regime, facilitating visa release for the business community in SECI region;*
- *facilitating the transport of commodities and passengers – reducing the waiting time at the borders of the express trains, transferring the*



road transport to the river route provided by the Danube;

- the energy efficiency – achieving a regional network for the efficient use of the energy and water resources;
- interconnecting the electrical systems – rebuilding the power stations and lines in Bosnia, Herzegovina and Croatia, creating a tele-informational system to connect the energy systems stations;
- interconnecting the gas networks – making investments in the expansion of the existent networks and interconnecting with the international pipes;
- fighting against the across-border criminality;
- fighting against global terrorism;
- cooperation between capital markets – increasing the share the SECI countries receive of the international capital fluxes;
- commercial arbitration and mediation – creating SECI Expert Group and the Centre for the Promotion of Arbitration and Mediation;
- other projects – achieving new communication technologies, water management and residual water treatment¹⁶.

SECI Regional Centre in Bucharest has been operational since January 2001.

2. Proposals on the cohesion of the Wider Black Sea area cooperation initiatives

The maritime continuity towards the Mediterranean Sea and the Atlantic Ocean and also towards Danube's hydrographic basin includes the Black Sea on one of the most important trade and tourism route. In the current context of globalization and increase of the need for energy resources, the Black Sea basin is important not only as energy transport route but also as a potential energy supplier (petrol and natural gas).

This space, so important nowadays for many global actors, can be stabilized and secured only by the will and contribution of all states and international organizations, in pragmatic and effective institutional frameworks meant to promote and protect the common interests of the countries determined to participate at the actions to ensure a stable security environment¹⁷.

2.1. Establishing a unitary framework of military maritime cooperation of the states in the Wider Black Sea area

In order to achieve a unitary framework of military maritime cooperation of the states in the Wider Black Sea area, we must analyze the reasons of the two initiatives, BLACKSEAFOR and Black Sea Harmony.

BLACKSEAFOR initiative started from the idea of cooperation between the navies in the area in a legal framework agreed upon by consensus, with a diplomatic character. The goal of the missions accomplished within this initiative was to strengthen trust, understanding and dialogue between the partner states.

However, especially after 9/11 2001, the BLACKSEAFOR structure, its biannual character, exercises and the degree and method of involvement of the participant states didn't seem to answer the needs for maritime security at the Black Sea. Turkey wanted an increased cooperation by establishing, in March 2004, the new naval cooperation structure, Black Sea Harmony¹⁸.

In our opinion, a unitary framework of military maritime cooperation of the states in the Wider Black Sea area must have the BLACKSEAFOR initiative as a central pillar. This represents already an effective cooperation tool in the field of interoperability between the Black Sea states' military navies, as the only regional initiative bringing these states together.

A variable of this unitary cooperation framework can be achieved by adding to the BLACKSEAFOR components some new ones regarding the improvement of maritime knowledge (collecting maritime data and information) and the integration of information (achieving data and information management, their analyses and dissemination), in accordance with the US national initiative of knowing the maritime domain at global level – "Maritime Domain Awareness".

The success of thus possible development of military maritime cooperation depends largely on the maximum transparency in exchanging information at BLACKSEAFOR level by using the "need to share" principle. This was defined in the US Congress 9/11 Commission's Report as being the necessity to join classified information of all the informative authorities regarding different subjects in order to be accessed horizontally by the other structures with attributions in the field and



vertically by the empowered substructures¹⁹.

In order to put into practice these cooperation mechanisms based on exchange of information, the BLACKSEAFOR member states must establish data collection and analysis systems meant to ensure collecting and disseminating information to own and other member states governmental structures. For instance, a country's governmental structures will be warned by others with similar attributions if they obtain information about maritime ships' suspect activities regarding the first country's harbours. Such activities can include: failure to respect the declared route, suspect persons within the ships' crew, goods or person transfer between two ships, executing manoeuvres or commodities transfer with possible negative consequences on the sea environment or seashore area.

2.2. The coagulation of economic cooperation initiatives in the Black Sea region

The analysis of the main economic cooperation initiatives in the Wider Black Sea area shows the fact that the economic links between the states in the region have expanded and diversified but they haven't consolidated. These initiatives were more foreign policy tools than forums of economic cooperation and integration; that's why we must rethink and merge the economic cooperation formats (which most have the same objectives).

In our opinion, the coagulation of the economic cooperation initiatives in the Wider Black Sea area must take into account the economic and political interests of the states in the area – and particularly those of Russia which is an opinion trainer in the area. Involving the EU in such a coagulation process can only be achieved by attributing a decisional and honorary role to Russia's representatives as well.

We believe that, in such conditions, the states in the Wider Black Sea area have the task to achieve this coagulation. A possible foreign financial and expertise support can come from a third state only indirectly.

The most effective method to achieve this coagulation process is focusing the efforts of the states in this region on a single initiative, the others being secondary (most of them ending their activities in a period of time decided upon by its members or by specializing on certain well-determined economic sectors).

In our opinion, among the economic

cooperation initiatives in the wider Black Sea area, the most relevant is the Organization of the Black Sea Economic Cooperation (BSEC) both for the non-member states and also for the organizational structure. At the same time, BSEC's initiative has had the longest and most visible activity at regional level. Another great advantage of this initiative is the US presence, as an observer. This presence will provide security for small countries which dislike the cooperation with Russia and Turkey (countries with an important economic potential).

The main obstacles to achieve such initiatives may result from the disputes between member states (Russia-Georgia, Russia-Ukraine, Armenia-Azerbaijan, Armenia-Turkey, Greece-Turkey), from the economic restrictions due to the fact that some of these states belong to different political and economic cooperation structures (European Union, Community of Independent States) and, not lastly, from the possible attempts of several states to control, directly or indirectly, such an interstate cooperation structure.

3. Conclusions

After 1991, a large number of regional cooperation initiatives have been developed in the Wider Black Sea area, those ones in the military maritime and economic domain having a more relevant impact.

The first conclusion regards the military maritime cooperation domain. The two initiatives, BLACKSEAFOR and Black Sea Harmony, have determined both the improvement of the relationships between the riparian states military leaderships and the increase of the security level of the maritime transport Pontic routes.

Planned and developed as an operation of cooperation between the navies in the area, in a legal framework agreed upon by consensus and with a diplomatic character, BLACKSEAFOR initiative represents the main pillar in achieving a unitary framework of military maritime cooperation of the states in the wider Black Sea area by encompassing new elements regarding the maritime situation and information integration in accordance with the US national initiative "Maritime Domain Awareness".

Another conclusion emphasizes the role of the economic cooperation initiatives which have developed mainly on political and not economic efficiency criteria. The most important initiatives



regarding the impact and regional visibility in the Wider Black Sea area are: Organization of the Black Sea Economic Cooperation, Black Sea Forum for Dialogue and Partnership and the South East Europe Cooperation Initiative. All of them have similar objectives, and different organization, members and links with the European Union and USA.

The most effective way to achieve the coagulation of the economic cooperation initiatives in the Wider Black Sea area represents the focus of the states in the region within the Organization of the Black Sea Economic Cooperation, the other structures with similar attributions are to be specialized or abolished.

REFERENCES:

- ALEXANDRESCU, G., *Dinamica modificărilor de paradigmă a securității Zonei Mării Negre*, Sesiunea internațională de comunicări științifice „Securitate și stabilitate în bazinul Mării Negre”, Centrul de Studii Strategice de Apărare și Securitate, Editura Universității Naționale de Apărare “Carol I”, București, 2005
- ASMUS, R. D., DIMITROV, K., FORBRIG, J., *O nouă strategie euro-atlantică pentru regiunea Mării Negre*, Editura IRSI „Nicolae Titulescu”, 2004
- BĂDESCU, I., *Tratat de geopolitică*, Ed. Mica Valahie, 2004
- BALABAN, C. GH., *Securitatea în zona extinsă a Mării Negre, o construcție cu un palier euro-atlantic și un palier local, prin acțiunea integrată a tuturor statelor care o compun*, Sesiunea internațională de comunicări științifice „Securitate și stabilitate în bazinul Mării Negre”, a V-a ediție, Centrul de Studii Strategice de Apărare și Securitate, Editura Universității Naționale de Apărare “Carol I”, București, 2005
- BUGAJSKI, J., *Medvedev’s wider Europe*, în „The Washington Times”, 17 iulie 2008
- COCHINO, A., *Rusia jubilează după deciziile NATO*, în „Evenimentul zilei”, 4 decembrie 2008, nr. 5372
- COȘCODARU, I., NEAGOE, V., *Un vis în devenire: Europa Unită*, Editura Axioma Edit, București, 2002
- DEGERATU, C., *Există Regiunea Mării Negre. Probleme de securitate ale unui spațiu geopolitic strategic cu o dinamică accelerată*, în „Monitor strategic – revistă de studii de securitate și apărare”, anul VI, nr. 3-4/2005
- DOLGHIN, N., DINU, M., POPA, V., *NATO, între certitudini și așteptări*, Universitatea Națională de Apărare, Centrul de Studii Strategice de Apărare și Securitate, 2004
- GAVRILĂ, G., *Implicațiile conflictului din Georgia asupra Securității în regiunea Mării Negre*, „Politici și strategii în gestionarea conflictualității”, Sesiunea anuală internațională de comunicări științifice, ediția a VIII-a, Centrul de Studii Strategice de Apărare și Securitate, Editura Universității Naționale de Apărare “Carol I”, București, 2008
- IONESCU, C., *Marea Neagră – un pivot geopolitic în dispută?*, în „Revista Geopolitică”, anul IV nr. 1(5), 2005
- ISPAS, TEOFIL, *Extinderea N.A.T.O. și securitate europeană*, în „Revista Academiei Forțelor Terestre ‘Nicolae Bălcescu’ Sibiu”, nr.2, 2001
- KIR, S., *Securitatea maritimă în Marea Neagră, BLACKSEAFOR și operația “Black Sea Harmony”*, Sesiunea internațională de comunicări științifice „Securitate și stabilitate în bazinul Mării Negre”, a V-a ediție, Centrul de Studii Strategice de Apărare și Securitate, Editura Universității Naționale de Apărare “Carol I”, București, 2005
- MARIN, GH., *Parteneriatele multilaterale și dialogul politic intensificat – soluții posibile în edificarea stabilității și securității în zona extinsă a Mării Negre*, „Politici și strategii în gestionarea conflictualității”, Sesiunea anuală internațională de comunicări științifice, ediția a-VIII-a, Centrul de Studii Strategice de Apărare și Securitate, Editura Universității Naționale de Apărare „Carol I”, București, 2008
- MARIN, M., *Turcia, membră UE în 15-20 de ani*, Standard.ro, 22 aprilie 2008
- MENON, R.; WIMBUSH, S. E., *Is the United States Losing Turkey?*, Hudson Institute, Washington, DC, March 2007
- MICLEA, M. S., *Caracteristici de securitate ale regiunii extinse a Mării Negre. Paradigma „securității înghețate”*, Centrul de Studii Strategice de Apărare și de Securitate, în „Impact Strategic”, Nr. 2 [27]/2008
- MÎRȘU, A., *Gruparea de cooperare navală BLACKSEAFOR în contextul securității bazinului Mării Negre*, Sesiunea internațională de comunicări științifice „Securitate și stabilitate în bazinul Mării



Negre”, a V-a ediție, Centrul de Studii Strategice de Apărare și Securitate, Editura Universității Naționale de Apărare “Carol I”, București, 2005

MUREȘAN, L., *Noua axă geopolitică Marea Caspică-Marea Neagră-Marea Mediterană. Energie și securitate – oportunități și sfidări pentru România*, în volumul *Integrarea euroatlantică. Priorități post-Praga*, Editura AISM, București, 2002

RETTMAN, A., *EU's new Black Sea policy faces Russian misgivings*, <http://euobserver.com/9/23494>, 16 februarie 2007

RUMER, E.; SIMON, J., *Contribuții la o strategie euroatlantică pentru regiunea Mării Negre*, în „Caiete euroatlantice”, Colegiul Național de Apărare, nr.2, Editura Universității Naționale de Apărare „Carol I”, București, 2006

STANCU, M. E., *Caracterizarea noilor riscuri, amenințări și acțiuni posibile în regiunea Mării Negre*, în „Buletinul Universității Naționale de Apărare ‘CAROL I’”, nr. 4/2007

STOICA, E., *Procesul de extindere spre est*, Asociația pentru Inițiative Civice, 16 februarie 2007, www.aic.org.ro

USCOI, N., *Uniunea Europeană și drumul său către o strategie comună de securitate și apărare*, în „Revista Academiei Forțelor Terestre ‘Nicolae Bălcescu’ Sibiu”, anul IX / nr.3 (35) trimestrul III – 2004

Studiu referitor la extinderea N.A.T.O. – septembrie 1995, IRSI, Centrul de Informare și Documentare, București, 1996

Final Report of the National Commission on Terrorist Attacks Upon the United States, US Congress, July 22, 2004

Sinergia Mării Negre – O nouă inițiativă de cooperare regională, Comunicarea Comisiei către Consiliu și Parlamentul European, Bruxelles, 2007

Summit-ul NATO de la București – sfârșitul unipolarismului?, Institutul Ovidiu Șincai, București, 10 aprilie 2008

Moscova: Extinderea NATO este incompatibilă cu realitățile lumii contemporane, Mediafax, 27 martie 2008

Geopolitical Diary: Lessons Learned from Georgia, Stratfor, 11 august 2008

Raport conferință internațională Regiunea Mării Negre – către un parteneriat al secolului al XXI-lea, Institutul „Ovidiu Șincai”, http://www.fisd.ro/PDF/mater_noi/Raport%20Conferinta%20

[Marea%20Neagra.pdf](#), accesat la 15.12.2008.

Conferința comună de presă a președintelui României, Traian Băsescu, și a președintelui Republicii Turcia, Abdullah Gül (Istanbul, 22 august 2008), http://www.presidency.ro/pdf/date/10147_ro.pdf

Promovarea în UE a regiunii Mării Negre – șansa afirmării României, <http://www.euractiv.ro/content/section%7CreadStorz>, accesat la 4.08.2008.

Black Sea Forum for Dialogue and Partnership, http://www.blackseforum.org/joint_declaration.html, accessed on December, 16, 2008.

PESC/PESA, <http://www.mae.ro/index.php?unde=doc&id=4951&idlnk=1&cat=3>, accessed on January, 4, 2009.

Politica europeană de vecinătate, Școala Națională de Studii Politice și Administrative, <http://www.snsa.ro/Noutăți/Ces/Politica%20europeana%20de%20vecinatate.pdf>, accessed on January, 8, 2009.

Sinergia Mării Negre – aducerea regiunii mai aproape de UE, <http://europa.eu/rapid/pressReleasesAction.do?reference=IP/07/486&format=PDF&aged=1&language=RO&guiLanguage=fr>, accessed on January, 10, 2009.

BLACKSEAFOR, Operational Aspects, http://www.blackseforum.org/English/Operational_Home.asp, accessed on January, 10, 2009.

Inițiativa de Cooperare în Sud-Estul Europei (SECI), Ministerul Afacerilor Externe, <http://www.mae.ro/index>, accessed on January, 11, 2009.

NOTES:

¹ALEXANDRESCU, G., *Dinamica modificărilor de paradigmă a securității Zonei Mării Negre*, Sesiunea internațională de comunicări științifice „Securitate și stabilitate în bazinul Mării Negre”, Centrul de Studii Strategice de Apărare și Securitate, Editura Universității Naționale de Apărare „Carol I”, București, 2005, p. 46.

²KIR, S., *Securitatea maritimă în Marea Neagră, BLACKSEAFOR și operația “Black Sea Harmony”*, Sesiunea internațională de comunicări științifice „Securitate și stabilitate în bazinul Mării Negre”, a V-a ediție, Centrul de Studii Strategice de Apărare și Securitate, Editura Universității Naționale de Apărare „Carol I”, București, 2005, p. 149.



³ MÎRȘU, A., *Gruparea de cooperare navală BLACKSEAFOR în contextul securității bazinului Mării Negre*, Sesiunea internațională de comunicări științifice „Securitate și stabilitate în bazinul Mării Negre”, a V-a ediție, Centrul de Studii Strategice de Apărare și Securitate, Editura Universității Naționale de Apărare „Carol I”, București, 2005, pp. 197-198.

⁴ Idem, p. 198, *BLACKSEAFOR, Operational Aspects*, http://www.blackseafor.org/English/Operational_Home.asp, accessed on January, 10, 2009.

⁵ RUMER, E., SIMON, J., *Contribuții la o strategie euroatlantică pentru regiunea Mării Negre*, în „Caiete euroatlantice”, Colegiul Național de Apărare, nr.2, Editura Universității Naționale de Apărare „Carol I”, București, 2006.

⁶ *Conferința comună de presă a președintelui României, Traian Băsescu, și a președintelui Republicii Turcia, Abdullah Gül* (Istanbul, 22 august 2008), http://www.presidency.ro/pdf/date/10147_ro.pdf

⁷ KIR, S., op. cit., p. 151.

⁸ RUMER, E., SIMON, J., op. cit.

⁹ *Promovarea în UE a regiunii Mării Negre – șansa afirmării României*, <http://www.euractiv.ro/content/section%7CreadStorz>, accessed on August, 04, 2008.

¹⁰ *Raport conferință internațională Regiunea*

Mării Negre – către un parteneriat al secolului al XXI-lea, Institutul „Ovidiu Șincai”, http://www.fisd.ro/PDF/mater_noi/Raport%20Conferinta%20Marea%20Neagra.pdf, accessed on December, 15, 2008.

¹¹ Idem.

¹² *Black Sea Forum for Dialogue and Partnership*, http://www.blackseaforum.org/joint_declaration.html, accessed on December, 16, 2008.

¹³ *Promovarea în UE a regiunii Mării Negre – șansa afirmării României*, <http://www.euractiv.ro/content/section%7CreadStorz>, accessed on August, 4, 2008.

¹⁴ *Inițiativa de Cooperare în Sud-Estul Europei (SECI)*, Ministerul Afacerilor Externe, <http://www.mae.ro/index>, accessed on January, 11, 2009.

¹⁵ Idem.

¹⁶ Idem.

¹⁷ STANCU, M. E., *Caracterizarea noilor riscuri, amenințări și acțiuni posibile în regiunea Mării Negre*, in „Buletinul Universității Naționale de Apărare ‘Carol I’”, nr. 4/2007, p. 142.

¹⁸ MENON, R.; WIMBUSH, S. E., *Is the United States Losing Turkey?*, Hudson Institute, Washington, DC, March 2007.

¹⁹ *Final Report of the National Commission on Terrorist Attacks Upon the United States*, US Congress, July 22, 2004.

Georgeta GAVRILĂ (ggavrila@mapn.ro) is the Secretary General of the Ministry of National Defence. She graduated NATO Defence College in Rome, the Program for Senior Executives in National and International Security at Harvard University, the Specialised Development Program for a position consistent with the Senior Civil Servant Status (organised by the National Administration Institute), and she is a PhD candidate in Military Sciences within the National Defence University “Carol I”, Bucharest, Romania.



IMPLICATIONS OF CHANGING THE CONCEPT OF ESTABLISHING THE US ANTI-MISSILE SHIELD IN EUROPE ON EUROPEAN SECURITY AND TRANSATLANTIC RELATIONSHIP

Teodor FRUNZETI, PhD

Nowadays, the security challenges have increased and diversified. That is why, the states adopt measures to prevent and limit the effects of security risks and threats. Establishing the American anti-missile shield in Europe represents such a measure. Putting it into practice has triggered mixed reactions of state and non-state actors, given the military, political, economic and social implications this measure generates.

Keywords: anti-missile shield, European security, transatlantic relation.

1. The Bush administration concept regarding “the establishment of the US anti-missile shield in Europe”

Generally, an “anti-missile shield” represents an ensemble of high-power radars and ground-air missiles launching and conducting installations destined to discover and destroy enemy ballistic missiles aiming at target state or states. The controversial American anti-missile shield is a project destined to protect the US and their allies against potential ballistic attacks coming from North Korea or Iran. Thus, Washington, using this system, intends to detect and destroy an enemy missile before it reaches its target on its territory or on a European state.

The American anti-missile shield project is based on the US new strategy regarding the response to the new international security threats. In 2002, Bush administration revised the American nuclear devices. The new strategy mainly aimed at discouraging the classical nuclear deterrence by increasing the deterrence capabilities against non-conventional attacks and by counteracting the proliferation of weapons of mass destruction.

To this end, the US foresaw the increase of their defensive capabilities so that they don't depend anymore on the offensive nuclear deterrence. The anti-missile shield is part of this concept, allowing the American leaders to focus their strategy on more conventional deterrence means.

The concept regarding “the establishment of the US anti-missile shield in Europe” initiated by Bush administration has led to the provision to establish the ground-air missiles and high-power radar launching installation in Poland and the Czech Republic. Thus, according to the US project, the radar in the Czech Republic will be installed in 2010. Washington and Prague reached a final agreement on this matter at the 2008 NATO Summit in Bucharest. The two parties signed an agreement in November 2008. The elements in Poland are to be installed in 2012 and 2013 and the US and Poland reached an agreement at the beginning of 2008. According to this agreement, Poland must station parts of the American shield and, in exchange, the US engaged to help Poland improve its air defence. Ten long-range ballistic interceptors were to be installed in Poland. Washington wanted to counteract any attacks of hostile states (Iran being on top of the list) against Europe and especially against the US. This project which had the approval of the ex-communist states, emphasized the tensions, more or less latent, between Moscow and Washington. Russia considered that this project threatened its national security. The anti-missile shield issue joins other disagreements between Russia and the US in the political and military field after the demise of the USSR and the changes in geostrategic configuration Russia supported in Europe and throughout the world. In fact, Russia declared its opposition



to all American strategic measures in Europe starting with NATO enlargement and ending with the regulations regarding the conventional weapons control. While during the first years the disagreements were only declarative, as Russia overcame the generalized system crisis following the 1991 events, it began to act starting with the ex-Soviet regions: it almost reached a strategic partnership with China and India, transformed the hydrocarbons issue into one of the continental security biggest problems. Moreover, for the first time in 20 years, the Russian state used its military power against Georgia, a clear message beyond the Caucasus region.

In fact, Moscow isn't concerned about the ten interceptors to be established in Poland, it is concerned about the **symbolic importance** of these weapons: *an American presence in the core of Europe*. The anti-missile systems Bush wanted to implement in the Czech Republic and Poland were the same as the ones they had put into practice at Fort Greely, Alaska, during the global protection program. These weapons belonging to the GBI Ground-based Interceptors category are enormous missiles the size of Minuteman intercontinental ballistic missiles. Such missiles are in silos designed to withstand bombardments. The 250 ha GBI complex in Alaska is connected to huge radar and uses 200 troops and a security force destined to monitor the traffic in the area¹.

In fact, Bush's plan was not to protect Europe, but to thwart Iranian missiles flying over Europe towards the US². The interceptors could protect several European regions but that was not their main function.

2. The Obama administration concept on "establishing the American anti-missile shield in Europe"

In September 2009, President Barack Obama announced the US abandon the Bush administration's program to establish an anti-missile shield in Europe. After having revised the Iranian threat, the US have decided to adjust the anti-missile shield project in Europe. Thus, the old project launched by the Bush administration is cancelled and a new concept of anti-missile shield in Europe is implemented. The Obama administration reached this conclusion after it had revised the Iranian ballistic threat. The result of

this analysis was that the US decided to revise the anti-missile defence program in Central Europe. The new concept stipulates shifting from a fixed ensemble (the old project) to a more polyvalent system (the current one). The old system was based on the assumption that Iran was determined to develop a long-range missile program but, according to the latest information, the Iranians focus on developing the short and medium range capabilities. The new anti-missile program was established to counteract the existent threats in Europe. The new system is destined to counteract the short and medium range missiles coming from Iran.

The current project proposed by the US refers both to Poland and the Czech Republic as locations for the anti-missile shield. For this purpose, Poland and the US prepare a Status of Forces Agreement (SOFA) which will allow the establishment of a new American anti-missile shield.

Thus, the Obama administration keeps a promise of its predecessor regarding the establishment of "Patriot" missiles in Poland. The first battery will be installed in 2010 in Wesola near Warsaw. Starting with 2014, Poland will receive 30 SM-3 batteries³. Their European command centre will be in the Czech Republic. This device is less expensive than the old system (10 millions instead of 70 million dollars) and, more importantly, it necessitates less personnel (100 instead of 400). According to the cited source, its installation should begin in 2014 in order to be operational one year later.

The change of the initial concept regarding the anti-missile shield in Europe can have the following reasons:

- In the negotiations about the Iranian nuclear weapons, the US cannot avoid the Russian influence. Thus, they hope that with this gesture, already approved by Moscow, to be able to improve the relationship between the US and Russia, relationship somehow tensed during the Bush administration. In this context, we mustn't omit Moscow's wish to play a role of mediator in the difficult Iranian issue.

- President Barack Obama wants to calm the game down. The current administration doesn't want to answer by making the same past mistakes. Thus, they put an end to the declarations of war by mere suspicions of national threats. As for Iran, the American experts are categorical, Teheran cannot send long range ogives (more than 5000 km).



○ Another more pragmatic reason is this: choosing a project less expensive than the initial one. On the other hand, the new anti-missile shield have been tested and proved more efficient in counteracting targets than those proposed by the Bush administration.

Referring to the new anti-missile shield, the president of the US stated that “the best method to improve our security and that of our allies in a responsible way is to deploy the best anti-missile system for the threats we must face and which use verified technologies we will pay for at a just price.”⁴

President Obama’s decision to adopt a new program of establishing the American anti-missile shield in Europe must be considered as it follows:

1. *The USA doesn’t give up the anti-missile defence in Europe* but continue with a new program. In fact, through the current anti-missile shield project, only part of the vast National Missile Defense program was abandoned. Washington cancels the deployment of the long range radar in the Czech Republic and a ten anti-missile battery in Poland that should protect the US against the Iranian ballistic threat.

To compensate this abandon, the US promised to deploy Aegis cruisers with anti-missile capabilities⁵. Also, “Patriot” missiles will be deployed in Poland.

2. *A courtesy gesture towards Moscow.* From the very beginning, Russia was against the program to establish an American anti-missile shield in Europe, as it considered it as a threat against it. In fact, the security threat was perceived both militarily (a very powerful radar at its gates) and geopolitically (the strategic component in Poland and the Czech Republic of the American defense system). For Moscow, the establishment of the American anti-missile shield in Europe represents another security challenge after NATO enlargement in the East. Improving the relationship with Russia is one of president Obama’s political priorities. The strategic matters represent a good topic for the discussions between the two countries, one of the few frameworks they are almost equals. The diplomatic calendar facilitates the things: two important treaties are due soon, START (limitation of strategic weapons) in December 2009 and TNP (Treaty of Non-Proliferation of Nuclear Weapons) in 2010. The two countries’ interest is to reduce their nuclear arsenals which represent 95% of the

world weapons⁶. Washington also needs Moscow in Afghanistan and in talks about Iran.

3. *Another gesture towards Teheran.* Cancelling a defensive system aiming mainly at Iran, is a positive change of the US toward this country considered an hostile state by America and the Western countries.

4. *A recognition of the US concern toward Europe’s security in general and Eastern Europe in particular.* However, the Polish and Check governments, very pro-American, as all the ex-communist countries, feel somehow betrayed by Washington in favour of the great Russian neighbour, by the changed concept to establish the American anti-missile shield in Europe.

5. *An adequate framework of the qualitative improvement of the relationship between Russia and the US.* If this thing is achieved, then we may witness an improvement of the relationship of NATO, EU and Russia, which would create the conditions necessary to build a new architecture of the European security.

6. *Improving Israel’s defence and the given political signal, that this state remains a strategic priority for the US.* In the Middle East, the US presence is necessary to counteract the actions and activities of what the Americans call “hostile states” and their weapons of mass destruction (WMD). In order to support Israel, Washington decided to create an air defence anti-missile shield in this country, the Arrow missile system. This shield is a continuation of the partnership between the US and Israel, concluded in November 2008, against the WMD program, nuclear programs of some extremist regimes in the region and the development of international terrorism. Moreover, the establishment of the new American anti-missile shield in Europe, with the purpose of striking the Iranian short and long range missiles completes the current measures and is considered as a strong political signal of the US attitude very favourable towards Israel.

3. The European security considering changing the concept of establishing the US anti-missile shield in Europe

Changing the concept of establishing the US anti-missile shield in Europe is turned into a program for providing the US and the European states’ security, a project which considers, to some



extent, Russia and EU's options regarding the new European security architecture. This concept changing has to be perceived as a process whose components are an ensemble of interdependent actions and activities of conceiving, organizing, developing and the optimal functioning of the project for establishing the US anti-missile shield in Europe.

Therefore, this concept changing will generate strong and different, in nature, implications (political, military, social and economical) which, on their turn, will influence, in a way or another, the European security and the transatlantic relations.

The positive influence on the European security will be exercised on its following dimensions:

➤ *The military dimension of the European security.* The influence will result from the higher quality of the new installations for launching and conducting the ground-air missile launching and the high-power radar, in order to timely discover the future targets (the enemy's missiles with short and medium range of action), and for displaying the anti-missile shield. Also, the staff from the shield's technical areas has a high professional training, and the launching installations have been tested and proved to be effective in combating targets.

➤ *The social dimension of the European security.* The establishment of the American anti-missile shield in Europe is perceived by the European citizens as an additional guarantee for life's safety and their activities. Therefore, there resulted an augmentation of the population's trust, both in their national governments, and in EU structures and US. On the other hand, this population's trust is built on the shield's high efficiency, whose components have been successfully tested.

➤ *The economical dimension of the European security* The shield's installation, the launchers and the station for guiding the ground-air missiles, and the high-power radar, involve important investments and the creation of places of work, including the local population. Both measures will have positive effects on people's standards of life and on those towns. Therefore, the host-nation's economy gets a financial support, and not only, being able to increase its specific contribution to the national security.

➤ *The political dimension of the European security.* Establishing the US anti-missile shield in Europe strengthens the alliance between EU and

US, also expressing a politic relation characterised by continuity and mutual understanding, on all levels, including the defence and security matters.

It is obvious that establishing the US anti-missile shield in Europe will have some *less wished consequences* for the European security. Among them, we may mention:

✓ The possibility for the other big powers of the world and for the states determining the approval of such a measure (the establishment of the anti-missile shield) to perceive it as the debut for a new arming race. That may stir a possible "race" between competitors for endowing themselves with the latest fight means and finding the best places for establishing them.

✓ The states where the new installations of the anti-missile shield are located may become an almost certain "target" for short and medium range missile attacks. Undoubtedly, the ones targeted by the shield's armament will concretely react against the new military objective.

✓ Tensioning the relations between US and Russia, as the latter, by the establishment of the new American anti-missile shield, perceives as threatened its efforts for regaining the big world's power status. As a matter of fact, Moscow is not afraid of the American anti-missile which will be installed in Poland, in the coming years, as from the quantity perspective they are inferior to Russia's possibilities for launching some ballistic missiles which overcome this shield's destruction power, but of the *symbolic value of establishing the anti-missile shield in the proximity of its territory, in a space which "belonged" to it 20 years ago.*

✓ The ongoing EU's dependency on defence and security of US and NATO. Obviously. EU has the Common Security and Defence Policy and its component, the European Security and Defence Policy, but there is still the dependence on US and NATO. As a matter of fact, EU builds its defence and security on each state's capability within this field and logistics provided by NATO.

✓ The expression of some serious obstacles against achieving the new European security architecture, wished both by EU and Russia. Lately, Moscow expressed its intention to be more actively and concretely involved in building a new security architecture in Europe.

✓ The effective deployment of the military display will take few years until it will actually be turned into operational. This may be perceived by



those states' populations as the shield is a security risks generator. First of all, by the period of time required for the concrete establishment and then by its "value", as a target of the new military objective represented by the anti-missile shield installations.

4. The transatlantic relations after modifying the concept of establishing the US anti-missile shield in Europe

In our opinion, putting into practice Obama's administration concept on establishing the US anti-missile shield in Europe will have both favourable and negative implications on the transatlantic relations between the US and the European Union.

Therefore, from the perspective of defence and collective security, establishing the US anti-missile shield in Europe will have the following *favourable implications*:

- Amplifies the flexibility of the European defence and security system, increasing its riposte capacity against missiles with short and medium range of action.
- Proves the real and constant interest of the US for the Europe's defence and security.
- It probes the US' resoluteness for respecting its commitments for EU, even if the American administration changed.
- Establishing the may be considered as a new measure for strengthening the mutual trust between US and EU on security, therefore, on developing the transatlantic relations. US anti-missile shield in Europe.

Also, modifying the concept regarding the establishment of the US anti-missile shield in Europe may have some unwanted implications on the quality, content, nature and ways for manifesting the transatlantic relations. We may mention among the possible *unwanted effects*:

- Maintaining EU's dependency on US on issues related with security and defence, therefore, generating, in time, a certain frustration feeling for the European citizens who aspire at increasing the European Union's international role on managing crisis and conflicts in Europe and around the world.
- The Europeans perceive the increased US military presence in Europe as an obstacle for creating new European security architecture

with its own forces and with Russia's consistent participation.

- Negatively affecting the transatlantic relations when it will be noticed that the establishment of the US anti-missile shield in Europe serves, first of all, the US strategic interests and then the Europeans ones.

- The way US have decided on establishing the anti-missile shield in Europe may negatively affect the transatlantic relations. As a matter of fact, US discussed directly with the European states where they wanted to install the shield, and not with the EU, as an entity representing 27 European states, also on defence and security matters⁷.

- The establishment of the US anti-missile shield in Europe maintain EU as a subordinate of US, and not as a partner with equal rights. In time, this may negatively affect the developments of the transatlantic relations. There are already EU member states willing to increase its role on matters related with defence and security. France's position is relevant here, as it perceives the European Security and Defence Policy as a "future European defence, a factor of a new pole power in a *multipolar world*"⁸.

Conclusions

The changes within the concept for establishing the US anti-missile shield in Europe is an ongoing process for flexible adaptation of the measures generated by the seriousness and the imminence of security dangers, risks and threats targeting Europe and US. This complex process also probes US capacity for respecting their commitments on security and defence to Europe, to their allies and partners.

Meantime, changing the concept for establishing the US anti-missile shield in Europe generates a set of direct, profound implications, different as meaning and ways of manifestation, and types (military, social, political, economical). On their turn, these implications are both positively and negatively reflected on the European security, on quality, nature and forms for achieving the transatlantic relations between the United States of America and the European Union. That is why, in time, it is possible for EU to opt for augmenting its efforts on defence and security, for diminishing its considerable and significant dependence on US in this field. Nowadays, the European Union



is an economic giant which has the required and sufficient human, material and financial resources for turning into a worldwide political actor. In other words, an actor having an increased role on security and defence issues, and on managing crisis and conflicts in Europe and world.

REFERENCES:

1. *Analyse: quatre remarques sur l'abandon du bouclier antimissile*, <http://secretdefense.blogs liberation.fr/defense/2009/09/analyse-labandon-du-bouclier-antimissile.html>
 2. BOUHOURS Damien, *BOUCLIER ANTIMISSILE – Obama revoit sa trajectoire*, <http://www.lepetitjournal.com/content/view/46958/204/>
 3. KAPLAN Fred, *Missiles: Obama renonce à un bouclier inutile*, <http://www.slate.fr/story/10533/en-renoncant-au-bouclier-obama-bien-fait>,
 4. GROS-VERHEYDE Nicolas, *Bouclier antimissile*, <http://bruxelles2.over-blog.com/categorie-10503113.html>
 5. MATES Michel, *179 STC 07 F bis - Debat sur la defense antimissile*, <http://www.nato-pa.int/Default.asp?CAT2=1159&CAT1=16&CAT0=2&COM=1289&MOD=0&SMD=0&SSMD=0&STA=&ID=0&PAR=0&LNG=1>
 6. MONGRENIER Jean-Sylvestre, *L'improbable défense européenne*, <http://www.cairn.info/revue-herodote-2008-1-p-9.htm>,
 7. PICARD Michel, *De la composante navale de la Missile Défense*, http://www.frstrategie.org/barreFRS/publications/pv/defenseAntimissile/pv_20070524.pdf
- De PRIMIS Roberto, *Vers une indifférence transatlantique?*, http://www.dandurand.uqam.ca/uploads/files/publications/etudes_raoul_dandurand/rd_intetude18web_091005.pdf

[ca/uploads/files/publications/etudes_raoul_dandurand/rd_intetude18web_091005.pdf](http://www.dandurand.uqam.ca/uploads/files/publications/etudes_raoul_dandurand/rd_intetude18web_091005.pdf)

NOTES:

¹ See Fred KAPLAN, *Missiles: Obama renonce à un bouclier inutile*, <http://www.slate.fr/story/10533/en-renoncant-au-bouclier-obama-bien-fait>, p.1.

² See Michel MATES, *179 STC 07 F bis - Debat sur la defense antimissile*, <http://www.nato-pa.int/Default.asp?CAT2=1159&CAT1=16&CAT0=2&COM=1289&MOD=0&SMD=0&SSMD=0&STA=&ID=0&PAR=0&LNG=1>

³ Cf. Nicolas GROS-VERHEYDE, *Bouclier antimissile*, <http://bruxelles2.over-blog.com/categorie-10503113.html>, p.1.

⁴ Cf. Damien BOUHOURS, *Bouclier antimissile, Obama revoit sa trajectoire*, <http://www.lepetitjournal.com/content/view/46958/204/>

⁵ See Michel PICARD, *De la composante navale de la Missile Défense*, http://www.frstrategie.org/barreFRS/publications/pv/defenseAntimissile/pv_20070524.pdf, pp.2-4.

⁶ *Analyse: quatre remarques sur l'abandon du bouclier antimissile*, <http://secretdefense.blogs liberation.fr/defense/2009/09/analyse-labandon-du-bouclier-antimissile.html>

⁷ Roberto De PRIMIS, *Vers une indifférence transatlantique?*, http://www.dandurand.uqam.ca/uploads/files/publications/etudes_raoul_dandurand/rd_intetude18web_091005.pdf

⁸ Cf. Jean-Sylvestre MONGRENIER, *L'improbable défense européenne*, <http://www.cairn.info/revue-herodote-2008-1-p-9.htm>

Lieutenant General Professor Teodor FRUNZETI (tfrunzeti@unap.ro), PhD, is the commandant (rector) of the National Defence University "Carol I". Having one doctorate in military sciences and one in political sciences, he is a remarkable researcher, author and co-author of more books related to military topics, security and defence, and also of over 100 specialty articles.



REGIONAL COOPERATION IN THE BALKANS AND SCANDINAVIA. PARTICULAR APPROACH – GLOBAL EFFECTS

Virgil BĂLĂŢEANU, PhD
Adrian VOINEA

Our current essay approaches in a comparative manner two distinct geographical areas quite different as potentially generators of cooperation – the Balkans and Scandinavia – analyzing the regional initiatives' role in identifying some viable solutions aimed at providing stability and prosperity within the actual European and Euro-Atlantic security environment, analysing these regional initiatives' evolution from their establishment, the active role initially assumed and development trends in the context of new security challenges and further threats.

Keywords: Balkans, Scandinavia, regional cooperation, Black Sea Region, geostrategy, Nordic Balance, global security.

The concept of international cooperation has positive connotations, by its classical definition thus implying a deliberate adjustment of policies by those states trying to settle one common problem while sharing mutual benefits. In this context, the regional cooperation initiatives are representing critical sources of enhancing security aimed at demonstrating mutual trust and confidence; they should involve all elements and forms of collaboration and address every field facing emergent security risks and threats at any level these may occur in order to provide fast development and stability for that region. Consequently, those challenges require an increasing role of regional security cooperation bodies that, in conjunction with the international ones, could achieve an effective and real regional security architecture through an active participation by all political factors involved as parts of European and global security architecture.¹

Therefore, the **regional cooperation initiatives** arose as a necessary step for providing security

by its beneficiaries themselves. The collocation “not only consumers but also security providers” has thus got consistency. We may assert that for the large majority of countries participating in regional initiatives, Romania included, there was a preliminary phase prior to their joining the European and Euro-Atlantic security organizations in respect of achieving several interoperability objectives, demonstrating good neighbourhood relations and even reforming their own Armed Forces by increasing professional standards as necessary to meet the requirements of new relationship system, interaction and mutual support.

A compelling analysis of military regional cooperation initiatives could not be accomplished but for an accurate radiography of the context they arose and which has definitely been generated by geopolitical particularities of the two distinct geographical areas under our consideration, we have tried to present eventual similarities and concurrent aspects on one hand and specific distinctions or disparities on the other hand, as identified throughout our succinct study.

The Balkans Area

An overview on the Balkans' area relieves a conglomerate of states at different stages of development or consolidation of their democratization processes. For instance, referring to their relationships with NATO and European Union, we should underline major discrepancies existing among such countries as Greece, a traditional member of both international security bodies, and Bosnia and Herzegovina, that was recently recognized by the international community after the '90 Civil War. The European Union is perceived by most people as a “self-agreed



empire”, able to restore normality and productive co-existence in the Balkans. The optimistic alternative is strongly supported by some countries believing that only consigning certain statehood prerogatives to Brussels institutions, they could expect some support for bargaining off poverty and corruption that most people incriminate their national leader as being responsible for. Many of these hopes are likely to be dashed as the EU enlargements in 2004 and 2007 have successively overburdened their institutions and budgets thus substantially diminishing the political will for another new enlargement in the near future.

Fairly speaking, the democracy is quite visible in all the Balkans area, but in a form not always recognized by those communities exercising a long traditional democratic experience. There is no doubt that there is progress but unfortunately it is permanently menaced by extreme nationalism, corruption and organized crime.

The Scandinavian Area

During the Cold War, the Nordic Countries' security policies were known as “*Nordic Balance*” – representing an ensemble of policies meant to preserve the balance between the two superpowers. It is a fact that the end of the Cold War opened the way towards a different while more comprehensive approach of security concept; within this new context, the Nordic countries need a certain time to properly respond while adapting their own policies and politics to the newly created security environment. There are some voices claiming that Nordic Countries have mainly focused on finding appropriate responses to the European Union enlargement process rather than adapt themselves to the new security environment as created following the Cold War ending.

Nevertheless, the Nordic Countries' traditional peacekeeping experience is also demonstrated by their participation in regional cooperation initiatives aimed at preserving or creating a steady security environment in areas of their own topical interest. Under these circumstances, to set out the areas of interest is compulsory requesting a complementary approach which exceeds the framework of this study and will not be currently addressed. However, it could be noted that gradually broadening of the international security bodies/organizations resulted into substantial

transformations of reference parameters when assessing the areas of national interest.

Increasing defence cooperation among the Nordic Countries is due to the need of economic resources availability and their security policies' transformation, as well. The Nordic countries defence cooperation is not a substitute for NATO and European Union, but envisaging the development of a common defence potential to be additionally contributed to NATO and EU military capabilities.

The regional cooperation initiatives in the Balkans

Romania has been actively participating since the mid '90s in several regional cooperation initiatives, based on memoranda of understanding or different agreements concluded with partner countries, in order to appropriately meet the requirements of enhanced regional security.

The Multinational Peace Force South-Eastern Europe (MPFSEE) is a highly visible regional cooperation initiative, and so is its military component **South-Eastern Europe Brigade (SEEBRIG)**.

The proposal of establishing the Multinational Peace Force South-Eastern Europe was launched on the South-Eastern Defence Ministerial (SEDM) on 3rd of March 1997, in Sofia. The MPFSEE project is developed under the SEDM auspices, getting together NATO member nations, P4P countries and the United States as an outstanding while very active partner of cooperation.

Under SEDM's umbrella, there are several cooperation projects such as *South-Eastern Europe Simulation Network/SEESIMNET*, *Interconnection of South-Eastern Europe Military Hospitals/SEDM-IMIHO*, *support by South-Eastern, Border Security and Fight against Terrorism/ CBSC*, *Europe Ministers of Defence for Non-proliferation of Weapons of Mass Destruction*, *South-Eastern Europe Military Education and Cooperation/SEMEC* and *South-Eastern Europe Defence Industry, Research and Technology/SEEDIRET*, all of them aimed at developing military regional cooperation, assisting the Balkan countries' Armed Forces reforming process and their possible further integration into the North Atlantic Alliance security structures. Romania is a reliable partner of cooperation participating in all these projects and



is ready to take over SEEDIRET Chairmanship in 2010.

We do believe that SEDM/MPFSEE/SEEBRIG could be considered as a very important supportive factor for increasing credibility of several countries currently undergoing a NATO and EU integration process.

SEEBRIG is an "on call" force operating a multinational permanent nucleus staff (SEEBRIG HQ) currently located in Istanbul.

Romania hosted SEEBRIG Headquarters for four years, 2003-2007, in Constanța. It was that time when SEEBRIG HQ was firstly deployed on the Theatres of Operations in Afghanistan, from February to March 2007 in Afghanistan, clearly demonstrating the viability of this regional initiative and its operational capacity of conducting real operations in a quite sensitive security environment. For Romania, the Host Nation of SEEBRIG HQ, the training proved to be a great challenge as we had to provide HQ support while deployed – one Communication Company and one Staff Company of about 230 personnel –, in addition to the Romanian military manning different positions within SEEBRIG multinational command.

We have to mention that any national module involvement in a peace support operation as SEEBRIG members is subject to national approval by all seven countries' Governmental authorities (Albania, Bulgaria, Greece, Italy, FYROM, Romania and Turkey) prior to deployment. SEEBRIG logo - "One Team One Mission" - has thus got consistency.

Another project of the regional initiatives was the Romanian-Hungarian Peacekeeping Battalion. This project was initiated in 1997 and became operational in 01.01.2000.

This initiative is a Romanian-Hungarian project supervised by France and Germany, meant to lead towards the enhancement of trust and friendship between the two Armed Forces while ensuring compatibility and interoperability at sub-units level of this mixed unit. The Romanian-Hungarian Peacekeeping Battalion was an extremely useful and necessary phase in the national module training, having multiple advantages for both sides, among which the increase of interoperability level was a long term major win.

Being located very close to Romania, the **Romanian Hungarian Slovakian Ukrainian**

Multinational Engineer Battalion "TISA" represents an initiative which responds to a wish for cooperation in another security field, of permanent interest, that of civilian emergencies. The objective of this initiative is the surveillance and emergency intervention in the areas affected by floods in the basin of the Tisa River or in case of other natural disasters in the area of responsibility on the territory of each party, as established by the Agreement. The Battalion is an "on call" force, operational since 01.02.2003. Its "partial deployment" is now envisaged by partners for a more flexible while efficient and realistic deployment only with specific elements of the battalion, pending on the type of mission and the scope of the calamity needing the intervention.

From the perspective of promoting a general secure climate through an active contribution to maintaining peace and stability in the region, we would like to mention a quite recent initiative, but one of a major interest in the Balkans area „The Balkan Countries Chiefs of Defence's Conference on Military Cooperation" constituted in a forum that ensures the optimum framework for the coordination of military cooperation and the strengthening of security at regional level.

The first reunion took place in April 2007, in Thessalonica, with the participation of the Chiefs of Defence from Albania, Bosnia-Herzegovina, Bulgaria, Croatia, Greece, Montenegro, Romania, Serbia, and Turkey. All these countries are either member of the North Atlantic or of Euro-Atlantic Partnership Council – EAPC.

In June 2010, Romania will host the 4th Conference. By their constant participation, as guests, the EU Military Committee Chairman and Naples Joint Force Commander, we may consider the initiative as one of interest for both international security bodies, and the current cooperation format, as well as the approached domains, among which asymmetric threats and other topics related to education systems, training and exercises, being placed under the global security policy promoted by NATO and EU.

The activities that have taken place up to now are clearly demonstrating that annual Balkan CHODs Conferences represent an efficient mechanism of increasing confidence and intensifying the armed forces' regional cooperation.

Other initiatives in the Balkan area, with implications in the security area, have in view



economic cooperation, environmental or transborder crime issues and have either a larger scope, re-uniting partners from other parts of Europe, benefiting from the support of great security actors, such as US, or they are established as bilateral or trilateral agreements.

We can mention, as part of the first category, the Southeast European Cooperative Initiative – SECI -, launched in December 1996, after signing Dayton Peace Agreement, at the common EU and US proposal, with the aim of developing a viable economic and environmental strategy in this region.

In order to address the Scandinavian space, we will mention another regional initiative, which, between 1997 and June 2009, gathered in a cooperation framework a number of 14 countries, from Argentina, Canada, Denmark, Finland, Norway, Sweden and Ireland. Romania joined this initiative from the first year of its existence.

UN Stand-By High Readiness Brigade – SHIRBRIG - was established based on the framework offered by UN *Stand-By Arrangements System – UNSAS*.

Even though the participant states to this initiative had an active involvement in solving security issues in certain crises areas by SHIRBRIG participation in UN missions in Ethiopia and Eritrea (2000), Liberia and Ivory Coast (2003), Sudan (2005 and 2007) for six month periods, starting with 2004 a series of malfunctions appeared, due to unavailability or inconsistency of the force package offered by member states of the initiative.

A number of states (Norway, Sweden and partially Denmark) expressed their worries concerning the possibility of engaging SHIRBRIG in a peace support operation, according to the current level of ambition and made series of proposals for the future of this initiative, including that of its termination. Therefore, SHIRBRIG was dissolute on the 30th of June this year by the unanimous will of member states.

Defence Cooperation Initiatives of Scandinavian states

As for the **Nordic states**, we can notice their preoccupation to create a regional power pole to include also a common and efficient military element. The states within this region are interested

in having a good position in the anticipated competition to exploit the natural resources of the ARCTIC region and control the new shipping corridors in this area. A common and coherent strategy is meant to consolidate their position as compared to the other major actors implicated in the Arctic issue (USA, the Russian Federation and Canada), under the conditions in which the existing national disagreements might paralyze NATO and EU attempts to assume new responsibilities in this region.

At present, the Nordic cooperation in the defence field encompasses three main formats:

1. Nordic Armaments Cooperation - NORDAC

NORDAC framework agreement was signed on December 2, 1994, subsequently amended on November 7, 2000. NORDAC main goals is to provide a good cooperation among the signing states (Denmark, Finland, Norway and Sweden), in order to gain some financial, technical and industrial benefits. This agreement was followed by the Agreement on security signed on September 1, 1995 and the Agreement on cooperation signed on February 15, 2001.

2. Nordic Coordinated Arrangement for Peace Supports - NORDCAPS

NORDCAPS represents a military cooperation forum of the Nordic states (Denmark, Finland, Iceland, Norway and Sweden), created in 1997 and agreed by the defence ministers. Its main goal was to strengthen the existing cooperation within the Nordic Cooperation Group on the military missions carried out under the UN aegis (Nordic Cooperation Group for Military UN matters - NORDSAMFN). NORDCAPS is aimed at adapting and developing the future cooperation of the Nordic states in the military peacekeeping operations field, based on the already proved military interaction, consolidate the “Nordic profile” for such operations and make efficient peacekeeping and international security efforts. Until now, there is no agreement to create permanent forces, as this is an independent decision on a case to case basis.

3. Nordic Supportive Defence Structures (NORDSUP)

In November 2008, a new defence cooperation structure was created with the participation of



Finland, Sweden, Norway, Denmark and Iceland, under the name of Nordic Supportive Defence Structures (NORDSUP).

The Memorandum of Understanding stipulates the development of national opportunities in order to maintain and develop operational capabilities and observe the principle of „cost efficiency”.

For 2009, the Finish Presidency proposed 48 cooperation fields, out of which the most important are: naval, land and air forces planning, military research and development, the Mechanized Nordic Battalion concept (in 2020) common maritime tactical situation of the Nordic countries (Sweden and Finland); cooperation of the submarine fleets (Sweden and Norway); tactical air situation of the Nordic countries; daily exchange of information on the air traffic at the borders; creation of the Nordic Defence University; creation of the Nordic countries logistic command and activities coordination among the Nordic countries on the air defence.

During the last period of time, there is a tendency to extend and intensify the cooperation of the Scandinavian countries by the creation of NORDEFECO – Nordic Defence Cooperation, with the participation of Denmark, Finland, Norway, Sweden and Iceland.

For these states, the strategic goal is to take increased responsibilities for managing regional security issues, besides NATO and EU role. Once the memorandum is signed, NORDEFECO (Nordic Defence Cooperation) will replace the three existing cooperation formats (NORDSUP, NORDAC and NORDCAPS). NORDEFECO presidency will be provided by the rotation of each state member, for one year mandate.

The achievement of the new military cooperation format meant to increase interoperability might be influenced in some fields, by an incompatibility aspect due to the fact that Sweden and Finland are not NATO members.

The materialization of the Nordic military cooperation will require a defence planning synchronization, meant to use the same type of equipments on a growing scale especially in the armament system field that needs increased costs for operation and maintenance. This will have consequences for the defence industry plan of the Nordic states, and a share of responsibilities among the states having the respective capabilities.

Conclusions

A first comparative analysis of the regional cooperation initiatives in the security field makes evident a common goal – peace, stability, democratic development and prosperity in this area – by using different means based on political, economical and even religious characteristics. Scandinavian states have a long democratic tradition and developed economies and they already have a certain kind of cooperation according to the principle of assuming equitable responsibilities, including financial ones, while in the Balkans area the regional cooperation initiatives are mainly focused on the integration of the new created states and the support of their complex evolution process to become authentic democratic regimes, real states of law and human rights observance. The fragility of the economic development increases the risk of the manifestation of religious and inter-ethnic confrontations, allegedly frozen or solved. The prevention of eventual conflicts in the Balkans area can be achieved, with notable results, as it was already done, through a military cooperation because it is well known that no matter where they might be, the military can find easily a common language since they are the most aware of the value and power of sustaining the entire social development starting from a stable and long lasting environment of peace.

In conclusion, we can ask a justified question why these geo-political areas of our contemporary world have been addressed within a common analysis.

A succinct answer could be that the security dimension of a society with a globalization tendency is a constant issue of all the actors involved, both as its beneficiary and providers, irrespective of their social, military or economic development level the role of each state should be assumed with the highest responsibility, according to the principle that a crisis situation no matter where or when can appear in any form, cannot and mustn't make us indifferent, the general progress to a real and stable democracy needs a long term conjugated effort.

Everything can determine that signs of a region's development may be discovered in a different "corner", without being absolutely necessary a mimetic policy but instead a policy of trust,



“mutual advantage” and good understanding.

An element that makes difficult the implementation of a similar vision in the Balkans is the still strong presence of a nationalist spirit specific for the Balkans countries, based on what the 19th century facilitated the creation of these state in the region.

If, *in extremis*, the nationalism is the Balkans’ “impediment” then “co-nationalism” is a successful story of the Scandinavian area.

It is extremely interesting to analyze the beneficial cooperation of the Scandinavian countries in the defence industry field and the achievement of common projects on armaments and equipment acquisition.

The field could be of interest for the Balkans area but a mature trust and the “influence” of nationalism will need at least a decade.

On the other hand, the North launches its initiatives starting from an internal process, the external influences are not significant and we can characterize them as an observation role. It is a completely different situation in the South -East where the influences outside the region are essential, because they have a leading role and supervise the regional initiative.

We can assume that the Balkans with the present tendency are not able to capitalize the cultural and historical “community”, political progress in the security, economic and social development fields, with a more profound understanding of the regional role and place, and the implementation of common defence project, in line with the “realpolitik” principles.

As a matter of fact, for instance, Forward Operation Sites – FOS -, the American project, reunites within JTFE (Joint Force Task East) Romanian and Bulgarian facilities.

We shouldn’t neglect future regional developments of Missile Defence policy and NATO and USA initiatives in progress.

In this respect, the evaluation carried out at national and NATO levels show that missile threats, especially mass destruction ballistic ones, are real threats under development and need efficient counteractions. The development of an integrated missile defence system, based on detection and interception capacities, is an essential component for the response to such threats.

Romania sustains NATO MD Initiative, namely the development of an allied system able to provide

a cover for the entire national territory, using as much as possible common funds:

- sustain architecture solutions able to cover and protect the entire national territory against the missile attacks analyzed, as scenarios, at the allied level;

- avoid initiative blockade and adopt a flexible and pragmatic position focused on project promotion and the highest benefits in any possible solution to be agreed at NATO level;

- promote a realistic way for the goal agreed on Bucharest and to adopt a process on stages, starting from the assessment of the threats’ imminence and the need to provide security for the most possible threats;

- sustain the actions meant to adapt the funding mechanism of using common funds and extend the eligibility for weapons and sensor systems.

Subsequent processes as for instance the affiliation to NATO commands, corps type, as well as the process of replacement of the weapon and equipment inventory specific to the Warsaw Treaty will direct the contributors’ efforts, *volens-nolens*, to a relative common direction.

Seeming a desideratum, the cooperation within acquisition and Article 5 - operations preparation will become on a medium and long term a possible remarkable achievement.

In this way, the individuality already recognized of the Scandinavian area will have a counterpart in the Balkans region.

Even more, we can foresee a long term “translation” of the South-East European regional initiatives towards the Caucasian space. Caucasus could be the Balkans’ mirror in the struggle for peace and prosperity.

REFERENCES:

1. Gheorghe MARIN, Corneliu BALTĂ, **Marea Neagră, între necesitate și realitate**, Editura CTEA, 2005.

2. Ronald D. ASMUS, Konstantin DIMITROV, Joerg FORBRIG, **O nouă strategie euroatlantică pentru regiunea Mării Negre**, Editura IRIS, București, 2004.

3. Prof.univ.dr. Adrian POP, prof.univ.dr. Dan MANOLELI, **Spre o strategie europeană în bazinul Mării Negre**.

4. Bruce Pitcairn JACKSON, statement made in front of the US Senate, *The future of democracy*



in the Black Sea region, March, 9, 2005.

5. Dimitrios TRIANTAPHYLLOU, The Security Paradoxes of the Black Sea Region, *Journal of Southeast European and Black Sea Studies* 9, no.3 (September 2009).

6. Tedo JAPARIDZE și Bruce LAWLOR, The

Black Sea: A Special Geography - An Explosive region, *American Foreign Policy Interests* 31, no.5 (September 2009).

NOTES:

¹ Admiral Gheorghe MARIN, PhD, *Multilateral Partnerships and Enhanced Political Dialogue*, 2008.

Major General Virgil BĂLĂCEANU, PhD, is the Chief of Strategic Planning Directorate from the Romanian General Staff.

Lieutenant-commander (Navy) Adrian VOINEA (voinea.adrian@mapn.ro) works for the Strategic Planning Directorate from the Romanian General Staff.



BONNE GOUVERNANCE DANS L'ACTUELLE CRISE ÉCONOMIQUE ET FINANCIÈRE

Petre DUȚU, PhD

Aujourd'hui, le monde traverse une profonde crise économique et financière. Cette crise a affectée tous le pays, c'est-à-dire elle représente un phénomène global, mais surtout les États en développement. C'est pour ça que les réponses à la crise doivent aussi être globale.

La Roumanie connaît aussi les effets de cette crise. Son gouvernement a pris des mesures pour dépasser cette crise.

Une solution pour sortir de la crise actuelle peut être la bonne gouvernance des affaires internes et externes du pays mais elle doit être accompagnée par une bonne gouvernance mondiale.

Mots clés: bonne gouvernance, crise économique et financier, impact de la crise économique et financier, mesures adéquates.

1. Caractéristiques de la bonne gouvernance

La gouvernance c'est la manière dont les gouvernements gèrent l'autorité politique, économique et administrative d'un pays. Elle peut être concevoir comme le processus par lequel une société se pilote et se dirige vers la réalisation des objectifs et des intérêts nationaux. Fréquemment, on parle de bonne gouvernance. Celui-ci suppose l'existence cumulée des éléments suivants¹:

➤ **La participation.** Celui-ci signifie que les citoyens du pays, des hommes et des femmes, participent directement ou indirectement (par les institutions intermédiaires ou représentatifs légitimes) aux affaires publiques. Il faut souligner que la démocratie participative ne signifie pas nécessairement que les préoccupations des plus vulnérables vont prendre par le leur nom lorsqu'on prend la décision. La participation impose l'information et l'organisation, c'est-à-dire la liberté d'association et d'expression, d'un part, et une société civile organisée, d'autre part.

➤ **La primauté du droit.** La bonne gouvernance demande que l'application des cadres juridiques soit équitable et impartiale. Elle prétend aussi qu'on assure tous les droits d'homme, notamment celles des minorités. Appliquer équitable des lois demande un pouvoir judiciaire indépendant et impartial, ainsi un police incorruptible;

➤ **La transparence.** Celui-ci montre que les décisions sont prises et met en œuvre selon aux règlements en vigueur. Elle signifie, en outre, que l'information donnée est libre et direct accessible ces qui sont visés par ces décisions si leur application. Dans le même temps, elle signifie que l'information donnée est suffisante et sous une forme facile accessible et compréhensible;

➤ **La réactivité.** La bonne gouvernance exige que les institutions de l'État répondent aux besoins et aux sollicitations des tous les citoyens, dans un temps raisonnable.

➤ **Le consensus.** La bonne gouvernance exige concilier aux intérêts divergents dans le sein de société pour atteindre à une large consensus sur ce qui représente l'intérêt général et comme on peut y arriver. Il prétend aussi une large vision et sur le long terme à ce qui est nécessaire pour atteindre un développement humain durable. Celui-ci ne peut pas résulter que de compréhension et de prise en compte du contexte historique, culturel et social d'une société donnée.

➤ **Équité et inclusion.** La bien-être de la société dépend de ce qui tous ses membres se sentent impliqués et pas exclus du courant principal de la société. Pour cela, toutes les groupes sociaux, mais ces le plus vulnérables doit avoir l'opportunité d'améliorer ou de garder sa bien-être.

➤ **L'efficacité et l'efficience.** La bonne gouvernance signifie le fait que les processus et les institutions de l'État produisent de résultats



qui répondent aux besoins de la société. Le concept d'efficacité dans le contexte de la bonne gouvernance, également couvre utilisation durable des ressources naturelles et la protection de l'environnement.

➤ **La responsabilité.** Celui –ci représente un exigence essentiel de la bonne gouvernance. Bien sur, il ne faut que seulement les institutions gouvernementaux soit responsable devant le public et les actionnaires institutionnalisés mais aussi le secteur privé et les organisations de la société civile.

On doit mentionner que les éléments composants de la bonne gouvernance sont dans une étroite interdépendance et interférence. La présence ou l'absence relative d'un élément, sa force ou sa défaillance peut influencer la manière d'agir d'autres composantes, soit permettre de la gouvernance d'être une bonne, soit par contre d'être une gouvernance inefficace, non efficace ou anti-efficace.

Par exemple, le renforcement des compétences dans le secteur public améliore l'efficacité de la fonction publique par institution des réformes organisationnelles, administratives et stratégiques. Ainsi, la décentralisation de la gouvernance dans le secteur public tant interne qu'externe (au profit des diverses institutions supranationales), accroît l'efficacité et l'obligation de rendre des comptes en sorte que le gouvernement soit présent à tous les niveaux de l'administration. D'autre part, la lutte contre corruption existante ou possible permet d'exercer tous les attributs susmentionnés de la bonne gouvernance. Un système juridique et judiciaire indépendante, accessible et impartial est la base même d'une gestion honnête et équitable. En même temps, une démocratie participative efficace satisfait la plupart des besoins fondamentaux de la population, ce qui permet aux autres paliers de gouvernement de s'occuper d'autres tâches.

La bonne gouvernance garantis aussi que les opinions des minorités sont prises en compte et que les groupes sociaux le plus vulnérables dans le sein de la société ont un mot de dire pendant de prendre les décisions. Ainsi, la bonne gouvernance est attendue et répond aux besoins présents et futurs de la société, de fait, aux besoins des citoyens du pays.

Enfin, la bonne gouvernance, exprimée par notions comme fiabilité, prospective et responsabilité, est conçu de plus en plus comme

un facteur clés de la prospérité des nations. Cependant, la plupart d'aspects de la relation entre bonne gouvernance et la prospérité sont toujours mal compris et peut certainement varier d'un pays à l'autre. Les évolutions économiques et sociales récentes suscitent une attention croissante de l'importance du rôle de la bonne gouvernance dans le développement économique et sociale. Les réformes de l'administration publique ont été un facteur significatif dans l'amélioration des capacités du pays de faire face aux problèmes liés de déficit budgétaire, aux pressions externes sur compétitivité du fait surtout d'une globalisation croissante, la perte de la confiance du public dans les gouvernants, la demande de plus en plus forte de services performantes et adéquates.

La bonne gouvernance en Roumanie, en tant qu'État membre de l'UE, doit répondre aussi à l'exigence de dernière. Ainsi, l'UE cherche de mettre en œuvre la notion de gouvernance démocratique dans les pays membre. Selon la conception et la pratique de l'UE, la gouvernance démocratique est un concept qui doit s'appliquer aux sphères sociale, économique, environnementale et politique d'un pays². Dans une approche large, la gouvernance démocratique comprend des problématiques aussi diverses que: le respect des droits de l'homme et des libertés fondamentales, l'accès pour tous à la justice, l'accès aux services sociaux de base, la promotion de la croissance économique et de la cohésion sociale dans un climat favorisant l'investissement privé.

En conclusion, la bonne gouvernance, par ses caractéristiques majeures- participation, primauté de droit, consensus, responsabilité, transparence, réactivité, efficacité et efficience, équité et inclusion – accomplit sa mission essentielle de gérer des ressources et des affaires du pays au profit des citoyens. Bien sur, son efficacité et son efficience est amplifiée dans les conditions dont ses efforts sont concertés avec ceux de la société civile et du secteur privé.

2. L'impact et le dynamique de l'actuelle crise économique et financière

La crise internationale qui s'est manifestée aux États-Unis à partir de l'année 2007 s'est propagée progressivement à l'ensemble des pays les plus développés de la planète. Elle a gagné le secteur réel des économies industrialisées



en mettant à nu la vulnérabilité de certaines activités (par exemple, l'industrie d'automobile et les transactions immobiliers) qui ont soutenu la croissance économique dans ces pays pendant de longues années. Les effets indirects de la crise se sont manifestés immédiatement dans les pays plus moins développés et puis les effets directs qui ont été assez de sévères pour ces pays.

Il est évident que actuelle crise économique et financière n'est pas surgi du néant. De fait, encore depuis les années 70, l'économie mondiale est marquée par de fortes fluctuations des taux de change et des prix des produits de base. La fréquence des crises financières (isolées et/ou systémiques) a également augmenté de manière considérable.

L'avènement de la crise des prêts immobiliers (*suprime*) en 2007 a ainsi été précédé par de multiple crises notamment celle de la dette des pays du Sud (1982), le krach boursier (Etats Unis, Europe du Nord) de 1987, la crise de change en Europe qui a entraîné la sortie de la livre sterling du système monétaire européen (1992 – 1993), la crise financière des pays asiatiques (1997) et l'éclatement de la bulle boursière Internet (2000)³.

En réalité, son apparition a été « annoncée » par divers phénomènes économiques produits surtout aux intervalles de temps 200-2005, 2005-2008, 2008-2009.

Dans ce sens, le dynamique de la crise le démontre complètement⁴. Ainsi, dans l'intervalle 2000-2005 se produit des phénomènes comme sont:

- Endettements des États du monde, surtout de États en développement; la crise de valeurs technologiques au printemps 2000;
- Mesures de relance de la croissance économique (augmentation des dépenses publiques, baisse des impôts et taxes, baisse des taux d'intérêt, facilités des crédits, nouveaux produits bancaires facilitant la consommation);
- Endettement généralisé de la part du secteur public, des entreprises et des ménages;
- Augmentation de la demande sur le marché immobilier et sur les marchés financiers (hausse considérable des prix de l'immobilier et des actifs financiers, amplification de l'endettement).

La période 2005-2008 se définis par les suivant aspects :

- Hausse des taux d'intérêt pour lutter contre l'inflation et limiter la spéculation financière;

- Raréfaction de la liquidité et du crédit;
- Chute de la demande, surtout de l'immobilier, et donc de leurs prix;
- Insolvabilité croissante des ménages à faibles revenus et défaut de paiement;
- Chute des prix des produits financiers dérivée aux crédits immobiliers;
- Début des crises d'institutions financières.

L'intervalle 2008-2009 se fait connu par les suivant phénomènes:

- Extension de la crise à l'ensemble de la sphère financière (marché financiers, banques d'investissement, compagnies d'assurance);
- Baisse de la liquidité, du crédit et de la demande;
- Extension de la crise aux secteurs d'activité économique;
- Extension de la crise à l'ensemble des marchés mondiaux (financiers, des matières premières);
- Volatilité sur le marché des changes.

A l'apparition et la manifestation de l'actuelle crise économique et financière ont contribué et d'autre facteurs. Ainsi, on peut mentionner⁵:

- L'accélération du processus de globalisation économique et financière durant la fin du XXème siècle s'est manifestée par un développement rapide des échanges de biens, de services et de capitaux, une intégration poussée des économies;
- Les difficultés de mettre en place de nouvelles règles acceptées et s'imposant à l'ensemble des acteurs. Ce déficit de gouvernance mondiale constitue ainsi une importante source de vulnérabilité et d'instabilité de l'économie mondiale;
- L'apparition de nouveaux acteurs, les pays émergents (Chine, Inde, Brésil et Russie) qui pèsent de plus en plus dans l'économie mondiale et contestent la suprématie des pays industrialisés de l'OCDE. Ce phénomène est illustré clairement par l'échec des négociations du cycle de Doha;
- L'incapacité des institutions internationales d'assurer la surveillance des politiques économiques (Fonds Monétaire International), le contrôle de l'activité des banques internationales (Banque des Règlements internationaux), la mise en place et le respect de règles régissant le commerce international (Organisation Mondiale du Commerce) prédispose



l'économie mondiale à des déséquilibres et des situations de crise. Ces problèmes de régulation de l'économie mondiale ont conduit ainsi à une volatilité des différents marchés internationaux (énergie, change, capitaux, produits agricoles), des phénomènes de polarisation (coexistence de pays dégagant de forts excédents commerciaux tels que les pays émergents et pays pétroliers et des pays déficitaires comme les États-Unis d'Amérique);

- L'insuffisance de coordination de l'action des banques centrales n'a pas permis de neutraliser les liquidités internationales qui ont alimenté la spéculation internationale et dopé successivement les cours de l'immobilier, des actions et des prix des matières premières, conduisant ainsi à la formation de bulles spéculatives;

- L'explosion de la bulle immobilière aux États-Unis, et les déficiences de la gestion du risque ont engendré la crise des subprimes. Les effets de propagation ont rapidement internationalisé la crise financière qui a agi négativement sur le secteur réel des économies développées. Ces dernières éprouvaient déjà beaucoup de difficultés pour s'adapter au nouvel environnement international.

Par la suite, l'actuelle crise financière et économique amène à l'apparition et la manifestation des dysfonctionnements dans l'économie nationale et l'économie mondiale ainsi que à la crise du système financier international. Dans ce sens, le développement des technologies de l'information et de la communication a favorisé l'accélération du processus de globalisation financière. A son tour, ce processus s'est caractérisée par plusieurs facteurs de fragilité et de vulnérabilité. Il s'agit en particulier des innovations financières, du crédit spéculatif, du modèle d'entreprise, des normes comptables, du comportement des fonds spéculatifs, du rôle des agences de notation et des banques centrales.

La transmission de ces défaillances (nées de la crise dite des «subprime», des prêts immobiliers) du système financier américain au système financier mondial à la faveur de l'intégration et de la globalisation des marchés financiers et bancaires, a induit un cycle de dépréciation des principales valeurs mobilières, et celles du secteur financier, une baisse de la liquidité bancaire et, sur l'année 2008, un bouleversement du paysage bancaire international, perceptible à travers des épisodes de faillites, de nationalisations et de rachats ou de fusion-absorption. Cependant, les effets de la

crise sont différenciés en fonction des pays et des régions du monde. Il semble que les plus affectés sont et seraient le pays en développement.

En plus, les conséquences de la crise actuelle financière et économique mondiale sont ressenties dans tous les secteurs d'activité humaine. Ainsi, la crise a un impact négatif sur : la croissance et le développement économique; le développement social; la commerce extérieur de tous les pays; la situation macroéconomique (les finances publiques, les flux financiers privés, la croissance économique).

En conséquence, la crise actuelle est sans doute la première d'un monde post-industriel et elle a un caractère global. C'est pour ça que, les solutions proposées doivent être à la niveau mondiale. Par la suite, les réponses à la crise actuelle supposent une régulation supranationale, non seulement nationale.

2. Démarches de la Roumanie pour échapper de l'actuelle crise économique et financière

A présent, Roumanie connaît complètement les effets de la crise financière et économique mondiale. Parmi eux se trouvent:

- Réduction des liquidités dans le secteur financier bancaire, en parallèle avec la majoration du coût du financement interne et externe;

- Durcissement des conditions d'obtention des crédits pour la population, agents économiques et secteur public;

- Augmentation du nombre des personnes en impossibilité de rembourser les mensualités et l'intérêt aux crédits bancaires;

- Baisse de la production interne, aux effets négatifs sur les revenus salariaux, sur le maintien des emplois et sur la profitabilité des compagnies;

- Baisse du rythme de croissance des rentrées publiques, à cause de la diminution, en général des activités économiques (industrie automobile, sidérurgie, non ferreux, constructions, ameublement, textiles etc.);

- Baisse du pouvoir d'achat et de la qualité de la vie;

- Ralentissement du rythme de croissance du produit interne brut⁶.

Ces effets négatifs et d'autres (grand déficit budgétaire, la capacité administrative réduite a conduit à un niveau bas d'absorption des fonds structurels, l'augmentation de la dette externe) ont un impact défavorable sur l'accomplissement par



les gouvernants des promissions électorales mais aussi du programme de gouvernement assumée lorsqu'ils ont pris le pouvoir politique dans l'Etat.

La sortie de cette crise difficile, a notre avis, suppose d'exercer une bonne gouvernance par la coalition qui se trouve au gouvernement, d'une part, et de concerter les efforts de la dernière avec ces du secteur privé et ces de la société civile, d'autre part. Dans ce sens, l'actuel gouvernement propose une série d'objectives à court terme. Parmi eux on trouve⁷ :

- Atténuer les effets négatifs de la crise financière et maintenir la stabilité financière (réduire le déficit du budget général consolidé; réduire le déficit de compte courant de la balance des paiements externe; garantir les conditions pour l'amélioration du rating de pays;

- Prévenir la transformation de la crise financière en une crise économique prolongée;

- Protéger les intérêts économiques de la population (pouvoir d'achat, capacité de remboursement des crédits bancaires, maintien des emplois) ainsi que la garantie de la sécurité sociale;

- Maintenir l'attractivité de la Roumanie pour les investissements dans les conditions de la crise, ainsi que la valorisation des opportunités spécifiques au contexte actuel;

- Assurer les conditions favorables pour la continuation du processus de convergence économique et le calendrier d'adoption de la monnaie euro le 1^{er} janvier 2014;

- Coordonner les mesures d'ajustement au niveau national avec la stratégie anticrise de la Commission européenne.

Mettre en œuvre toutes les mesures proposées par le Gouvernement de la Roumanie pour dépasser les effets de l'actuelle crise financière et économique suppose une gouvernance très bonne. A notre avis, il est nécessaire tant une conduite cohérente des affaires internes et externes qu'une concertation des efforts de tous les facteurs de décisions et responsables avec les énergies du secteur privé (qui doit soutenir par des mesures concrètes pour avoir une évolution ascendante et bénéfique pour tout le monde), avec le militantisme de la société civile et l'activisme des citoyens (qui doivent impliquer consciemment et responsable). Le Gouvernement, de fait, les personnes qui le compose ont cette tâche de dépasser et de sortir de la actuelle crise économique et financière, sans des pertes économiques,

financières et sociales majeures. Dans ce contexte, les mesures de type populiste et sans fondement réel économique et sans des ressources humaines, financières et matérielles sont très dangereuses et inefficaces pour sortir de la crise actuelle.

Attirer d'investissements étrangers significatifs comme force financière, accenser rapidement les fonds structurels, investir les ressources financières existants dans la préparation de main d'œuvre (reconversion, requalification, formation par les différentes cours de force de travail dans les secteurs dont l'économie nationale a besoin) sont, à notre avis, seulement quelques directions pour dépasser l'actuelle crise. En ce qui concerne le plan psychosocial, s'impose d'être créer, développer et consolider, par les mesures gouvernementales adéquates, le consensus national, le climat psychosocial, la cohésion sociale, l'implication de tous les citoyens dans le démarche de sortir de la crise actuelle.

Conclusion

La bonne gouvernance doit devenir une réalité dans tous les pays s'on désire son évolution ascendante, dans tous les plans- social, économique, cultural, politique, psychosocial.

La bonne gouvernance signifie, en essence, la conduite cohérente, efficace, efficiente et flexible des affaires internes et externes du pays. Cette chose se traduit par atteinte intégrale des objectifs établis par le programme de gouvernement, la défendre toujours d'intérêts nationaux et la sécurité de citoyens –sur tous les plans (social, économique, alimentaire, politique, militaire, individuel et collective).

L'actuelle crise économique et financière a un impact forte sur accomplissement de tâches spécifiques pour une bonne gouvernance dans un pays ou l'autre. De fait, on peut affirmer que l'actuelle crise économique et financière représente tant une provocation réelle, concrète et consistante pour la bonne gouvernance que une évaluation de la mesure dont existe ou non une telle conduite des affaires d'un pays.

RÉFÉRENCES:

1. *Contexte économique et financier interne et international*, <http://www.gov.ro/chapitre-3-engagement-pour-la-bonne-gouvernance-de-la->



roumanie__13a105142.html

2. *Encourager la bonne gouvernance*, <http://ec.europa.eu/development>,

3. GEMAYEL Joseph, *La crise économique et financière mondiale: enjeux et perspectives*, <http://www.slideshare.net/unte/la-crise-conomique-et-financiere-mondiale-enjeux-et-perspectives>;

4. MABURUKI Tembo Rachid, *L'impact de la crise financière et économique sur les économies africaines, le cas du Sénégal*, www.undp.org.sn/index.php?

5. *Les principaux éléments de la bonne gouvernance*, <http://bonnegouvernance.monsite.wanadoo.fr/page7.html>

NOTES:

¹ *Les principaux éléments de la bonne gouvernance*, <http://bonnegouvernance.monsite.wanadoo.fr/page7.html>

² *Encourager la bonne gouvernance*, http://ec.europa.eu/development/body/press-forum/monthly-topics/monthly_topic_10_2006_fr.pdf

³ Tembo Rachid MABURUKI, *L'impact de la crise financière et économique sur les économies africaines, le cas du Sénégal*, www.undp.org.sn/index.php?, p.4.

⁴ Joseph GEMAYEL, *La crise économique et financière mondiale: enjeux et perspectives*, <http://www.slideshare.net/unte/la-crise-conomique-et-financiere-mondiale-enjeux-et-perspectives>, pp.1-5.

⁵ Tembo Rachid MABURUKI, *art. cit.*, p.5.

⁶ *Contexte économique et financier interne et international*, http://www.gov.ro/chapitre-3-engagement-pour-la-bonne-gouvernance-de-la-roumanie__13a105142.html, p.1.

⁷ *Ibidem*, p.2.

Petre DUȚU, PhD (dutupetre@yahoo.com), chercheur degré deux au Centre d'Études Stratégique de Défense et Sécurité, sociologue militaire, auteur des livres et des nombreux articles sur la sécurité nationale, régionale et globale, ainsi que sur le moral des militaires et d'armée, etc.



IMPLEMENTATION OF NATO EBAO¹ DOCTRINE AND ITS EFFECTS ON OPERATIONAL STAFFS' STRUCTURE AND FUNCTIONS

Christophe MIDAN

Throughout the transformation process, NATO strived to integrate the most recent and effective reflections on the operational and overall strategy. In this context, when the permanent command structures have been transformed subsequent to the Cold War, starting with 1994, the Allied Command Transformation (ACT²) was established and headquartered in Norfolk (USA). ACT's most important goals are the development and implementation of NATO new doctrine³.

Among the most significant reflections issued by ACT is the EBAO doctrine which is an offspring of the American EBO doctrine that was used mainly by the USJFCOM⁴ at the beginning of 1990s but which has been updated and enriched constantly in the years⁵ that came. On the basis of this doctrine, the three operational⁶ commands had been tasked to develop an internal structure and a package of procedures for joint functions and this process is still underway. The future stage consists of the implementation of the structure and the use of EBAO for operation management. From this perspective, for instance, JFC Brunssum ended its transformation process in early September 2009. The other two operational staffs Naples and Lisbon encounter such a transformation in 2009.

The purpose of this paper is not to accurately describe NATO EBAO doctrine or the EBO development from its inception, but to summarize the tenets that are essential for the understanding of a doctrine which implementation will have very significant effects not only on Alliance's operation conducting but also on its structures and functions. Indeed, it will have radical effects and it will make the staffs leave the office-based structure established by the Prussian Staff in 1860s for a two-tier structure (three directorates subdivide into more offices) and this is indeed a tangible revolution. The author's intent is to explain as comprehensible as possible a doctrine

that is typically reserved for the connoisseurs, in order to allow the inexperienced reader an easier understanding of the fundamentals and effects in terms of structure and functions, as well as of the risks.

Keywords: NATO, EBAO, EBO.

1. Lineage and history

1. 1. Concept origin

The EBAO concept stems from studies performed at the end of the Cold War and intended to targeting⁷. The basic idea is to regard the adversary as a system and to target only his weaknesses in order to obtain an effect and thus generate a change in capabilities or system's behaviour. For instance, if it is intended to neutralize a communication network or a power supply system, the goal is to identify and destroy only those targets that play a critical role within its operational status (joints for connection or for traffic or power direction giving) being defined according to the time designated for neutralization and not according to the traditional approach which was in favor of a gradual falloff by targeting more joints of the network.

Actually, this approach is not entirely new. Without rejecting the stance of EBAO disciples who considered that the doctrine was working during Napoleon's⁸ times or even Sun Tzu's⁹ or Pharaoh Thoutmosis' III¹⁰, it is clear that the idea of targeting the vulnerabilities of the adversary is not new and it was used along the entire history of war¹¹. Nevertheless, there is a new thing - the willpower to influence the results of the actions over the capability and/or behaviour in a scientific manner and thus to maximize mathematically the desired effect on the adversary's forces or motivation. This approach came into being among the air warfare theoreticians during the interwar period both in Europe (Giulio Douhet) and in America (*Army Air Corps Tactical School*¹²).



For obvious material reasons, the concept was developed by allies and especially by the Americans during the World War II and led to “strategic” bombings against Germany and Japan. The idea which had been particularly supported by the American General William Mitchell was to identify the vulnerabilities of the German military-industrial complex (and Japanese), to tear down the adversary’s combat determination by destroying the houses of the workers and the industrial areas. This strategy might inflict cascade effects up to the bringing of the war machine to a halt, and also to the annihilation of the population will to fight, and thus bringing the adversary to his knees. Even if few effects had been obtained¹³, it was obvious that the Nazi economy and to a certain extent the Japanese one proved an unexpected capability to adjust and the German war machine was brought to a halt only when the allied armies invaded the territory of the Reich. Similarly, Japan had been defeated only through the systematic destruction of its production assets and especially of the supply ones (the well-known process of diminishing which was totally opposed to the effects concept) and through the use of the atomic weapon (terror which was also opposed to the effects concept). Finally, the first real experiment had not generated the desired effect but this issue had been considered as being connected to the lack of information and weapons’ precision¹⁴. After the World War II, the effects based war had been used (partially) many times through the dominant power exerted in the technology domain (USA, Israel) with more or less persuasive effects¹⁵.

1.2. The consequences of the revolution in military affairs on the development of EBAO Doctrine

Nevertheless, the revolution in military affairs announced by the approaching of the computers in the 1980s opened a new window to opportunities. The development was not only technological. Some developed a rich reflection on the network war and on the analysis of the adversary. Among them, a special role was held by the American Colonel Warden who developed the first theory of systemic analysis on the adversary¹⁶. Others developed the analysis on systems of systems and defined the way the connections among systems are made and which are the key points triggering systemic effects. On the other hand, an important

theoretic reflection led to the development of the patterns about the cascade effects and brought a *seeming* estimate of effects. According to this vision, theoretically it is possible to identify the vulnerabilities of the adversary in a scientific manner and thus the effectiveness of friendly actions may be increased¹⁷.

This context laid the basis for EBO doctrine that it was developed following the second war in the Gulf (1990-1991) and tested in Kosovo, during the third war in the Gulf (2003) and in Afghanistan. The result which was *seemingly* remarkable during the dynamic parts of the wars in Iraq and Afghanistan was used to justify the continuation of the experiment. Led by the USJFCOM with the enhanced support of the American Air Forces, the study was developed and gradually integrated into the American doctrine (as well as in the Israeli one or others). Meanwhile, the doctrine that had previously been conceived for high intensity operations was broadened and adjusted to the fights for stabilization and considerably came close to the DIME¹⁸ concept, with the purpose to encompass the non-military aspects of an operation. Obviously, given the fact that the chief of USJFCOM is also the chief of ACT, and the American forces decided to make the doctrinal efforts available to their allies, the concept was gradually taken into account by NATO decision-making forums.

1.3. The development of NATO EBAO concept

In NATO, the process was slower and the first official reference of a reflection on a new doctrinal research was made during the 2004 Summit in Istanbul. In fact, the acronym EBAO/EBO was not used, and in the final statement it was uttered that: „The nowadays complex strategic environment requires a *broader approach on security* that has to encompass political, economic and military elements”. Thus, it was not about EBAO in itself but an attempt to widen NATO doctrine towards political, diplomatic, economic and civilian dimensions. It was that very moment when ACT developed a reflection that integrated previous American studies on DIME concept, on network war, on operations’ development and targeting.

The second step was made in 2006 at the Summit in Riga where the 26 allies decided to develop the concept of *Comprehensive Approach*¹⁹, a reflection which was close to the American concept of



DIME. Given that this concept may be considered complementary to *EBO* doctrine, ACT combined the American studies on DIME and EBO with the purpose to adjust a new doctrine by amassing the two aspects. Along this process, the name of the doctrine has been changed from EBO to EBAO in order to reflect a new way of thinking that was broader than the first American concept²⁰.

The first *Pre-doctrinal Handbook*²¹ was published in December 2007 and in view of the fact that it was the most recent document approved officially by NATO, it is the basic current document for the development of the doctrine. Given that it is more compact than its previous versions, it is focused on operational and tactical levels and does not reflect on the political-military level considered in the previous documents. More studies are underway²² to augment this document.

2. Principles, objectives and decision cycle

2.1. Principles and objectives

As it was shown before, the EBAO principles have evolved gradually and are not unique in the world. Fortunately, NATO has been involved pretty late in the doctrine and has been able so far to define a unitary doctrine even if this is uncomplicated. In NATO, EBAO doctrine differs from the American EBO doctrine which has been its predecessor. The main theoretical bases are the following:

First of all, it is worth mentioning that the EBAO doctrine is conceived as a process intended not only to the assets (forces, combat equipment, logistics, and economic infrastructure... called *capabilities* in the EBAO doctrine), but also to the adversary's *behaviour*. Similarly to the ideas in the *Art of War* by Sun Tzu, the ultimate aim is to destroy the adversary's combat will and to make him give up combat. Therefore, the planning is envisaged so that the actions against the adversary should have *effects either on his capabilities or on his behaviour* and if possible on both.

The adversary and other actors are seen as systems of interdependent systems. For example, according to Warden, the adversary can be modelled as a system consisting of many sub-systems. This system interacts with other systems (including NATO actors) and the actions implemented by all actors may have consequences on other sub-systems²³ or systems²⁴ other than the intended one. The purpose of EBAO analysis is first of all to estimate which is the most appropriate action to

trigger the desired effect, where should this action be implemented (analysis of the vulnerable points of the systems) and which are the side effects for other systems, in order to decrease the unwanted effects and to increase the impact over the target through cascade effects.

The effects are stipulated by using the concept of SoSA²⁵, with the purpose to assess not only the appropriate point of implementation that means to make use of few friendly actions to obtain a maximum result, but also their impact on other actors and side or tertiary effects (...) inflicted by the first effect. Consequently, SoSA is supposed (at least theoretically) to help the commander implement the least possible use of violence in achieving a desired result (effect), being dissimilar to the traditional vision on gradual thwarting in adversary's assets, and lessen at the same time own expenses and damages.

Given that it is a doctrine for NATO operations in an international context, the EBAO concept relies on the *Comprehensive Approach Manner* and all planning is considered taking into account the environment not only in terms of own means (connection of political, diplomatic, economic, cultural means... with the military ones), and strategic actors (international community, NGOs, other actors), but also of concept (side effects of an action, interaction among the effects and reflection on the interdisciplinary impact (political, military...) of the effects).

Thus, the actions may imply the use of force or influence and communication with no negative effects on the target. They are applied over the adversary and also over other actors in particular with the purpose to change their behaviour in a desired manner and create an effect favourable to the Alliance²⁶.

2.2. Effects on the strategic and operational planning

According to its definition, the "effects-based approach to operations is the coherent and comprehensive application of the various instruments of the Alliance, combined with practical cooperation with non-NATO actors involved, to create effects necessary to achieve planned objectives and ultimately the NATO end-state."²⁷

This definition assumes that NATO has defined a planning framework in compliance with the

Comprehensive Approach Manner. The North Atlantic Council has integrated its end-state within this framework with the assumed international aim that is the common basis between NATO and other partners (United Nations, NGOs, partner countries).

This end-state which has been defined collectively by all 28 countries is articulated within a few intermediate *objectives* that are the necessary aims for the achievement of the end-state and that are defined clearly and explicitly.

To a lower level, the objectives are linked with the effects that are, in a simple manner of speaking,

influencing the capabilities and behaviour of the adversary, as well as of other actors.

Finally, the effects are linked with the *actions* of the forces or of other instruments used by the Alliance or other actors.

Planning strives to analyze the negative and positive consequences of the actions with the purpose to select the most appropriate ones and to draw up combinations of actions capable to have a systemic effect on the adversary and on other actors, namely the effect that is the most favorable to the friendly forces.

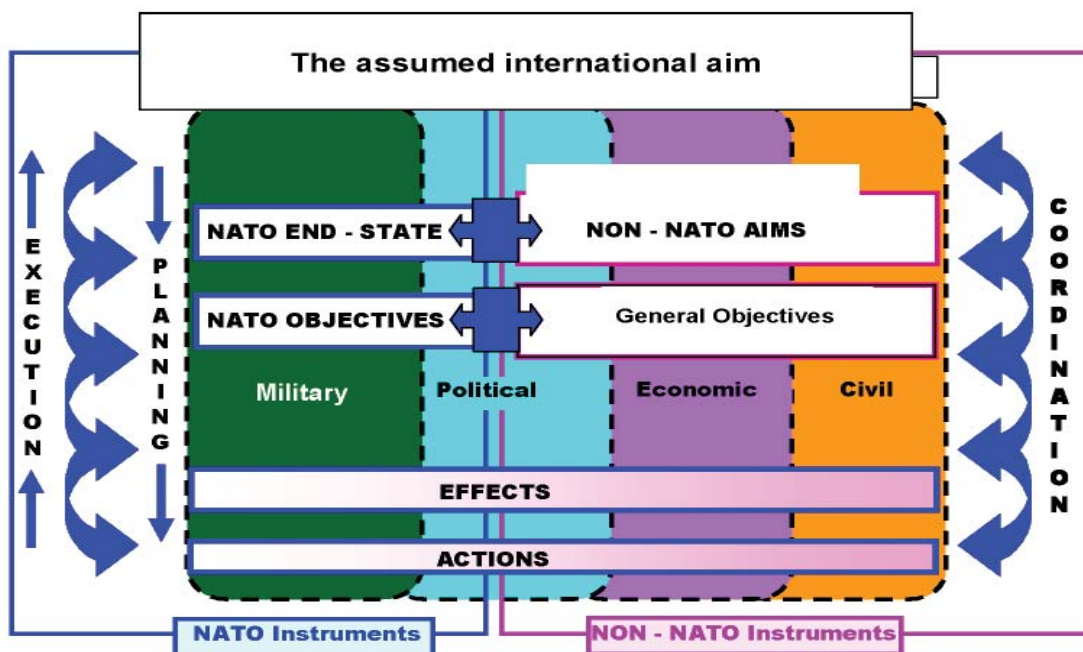

A graphic representation may be useful for a better understanding of the relations among various actors and the planning process:

Similarly to other planning methods, EBAO is a method that is intended to be flexible. Even if a significant part of this study is made upstream in order to analyze the systems of systems and to define the appropriate effects, the planning relies on the whole cycle of processes and assessments.

The effects are defined in order to be quantifiable by the staff.

A series of Measures of Effectiveness (MoE)²⁸ is developed for each effect.

These measures are conceived to assess as accurately as possible to what extent the behaviour and capabilities of the system are affected by our actions. They indicate if the desired effect is

reached, is near or an observable change in target's status is visible. The actions are also defined in order to be quantifiable on a regular basis through a series of Measures of Performance (MoP)²⁹.

Unlike MoE that are applied to the adversary's status, MOP are applied to the friendly forces and their objective is to measure if our actions are effective or not and to change, if necessary, our own course of action.

2. 3. Planning consequences at tactical level

At tactical level, the doctrine is simpler: actions correspond to tasks which are based on direct activities used by friendly forces.

The following chart indicates the links of an objective from operational to tactical level³⁰:

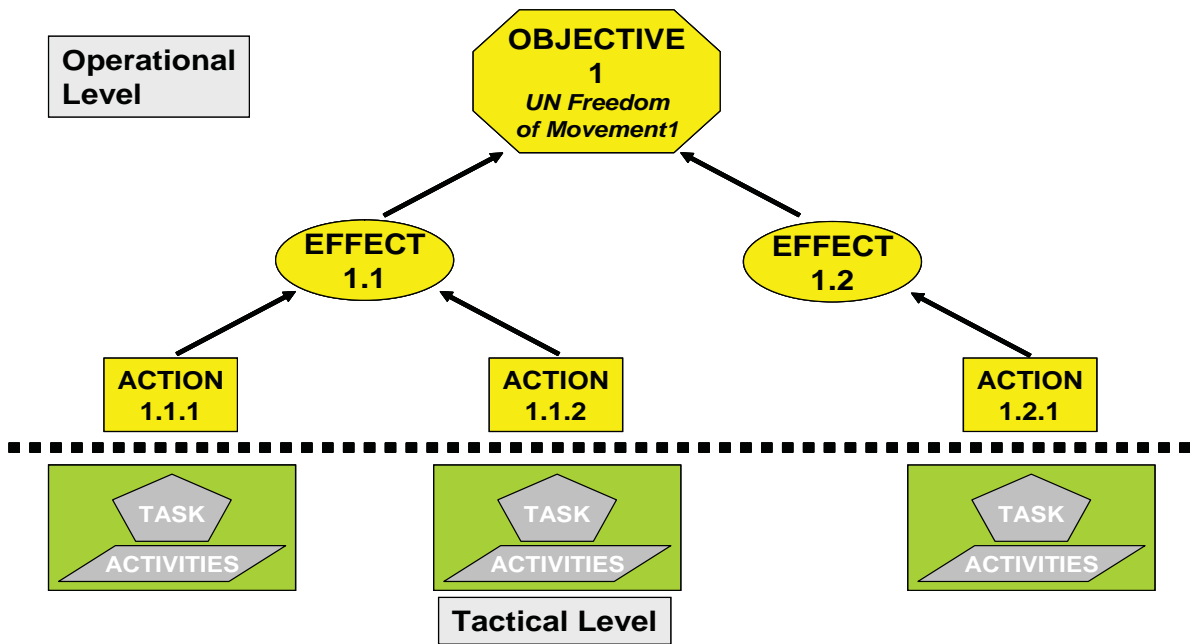

The following example, an extract from **EBAO Handbook**, is used for a better identification of the relations between the two levels³¹:

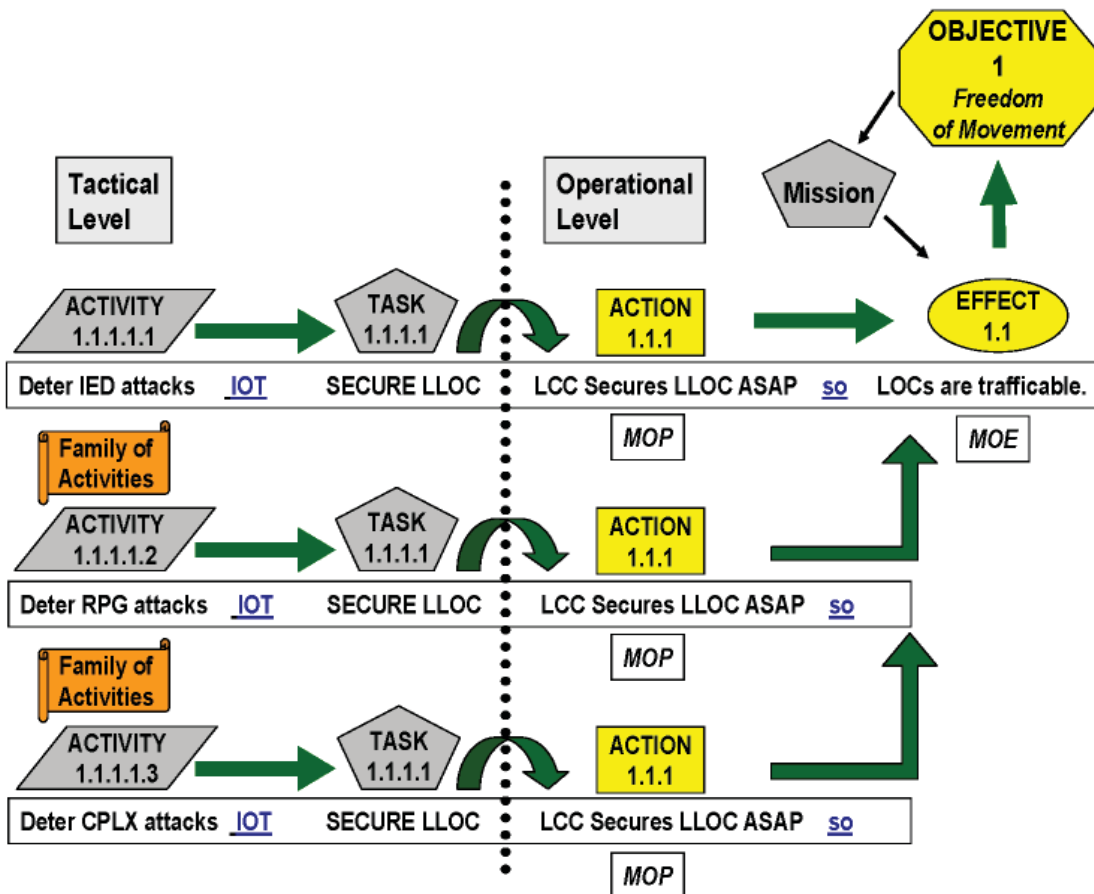

2.4. *Planning-assessment-management cycle*

A decision cycle has been defined in order to permanently assess the effects and actions at operational level and the tasks and activities at tactical levels.

The principle is the same for both levels: planning generates actions/tasks/activities which

results are assessed. The assessment's result is used to give new orders and the cycles resumes until the full accomplishment of the actions and then of the effect.

The system of planning-assessment-management can be charted like this:

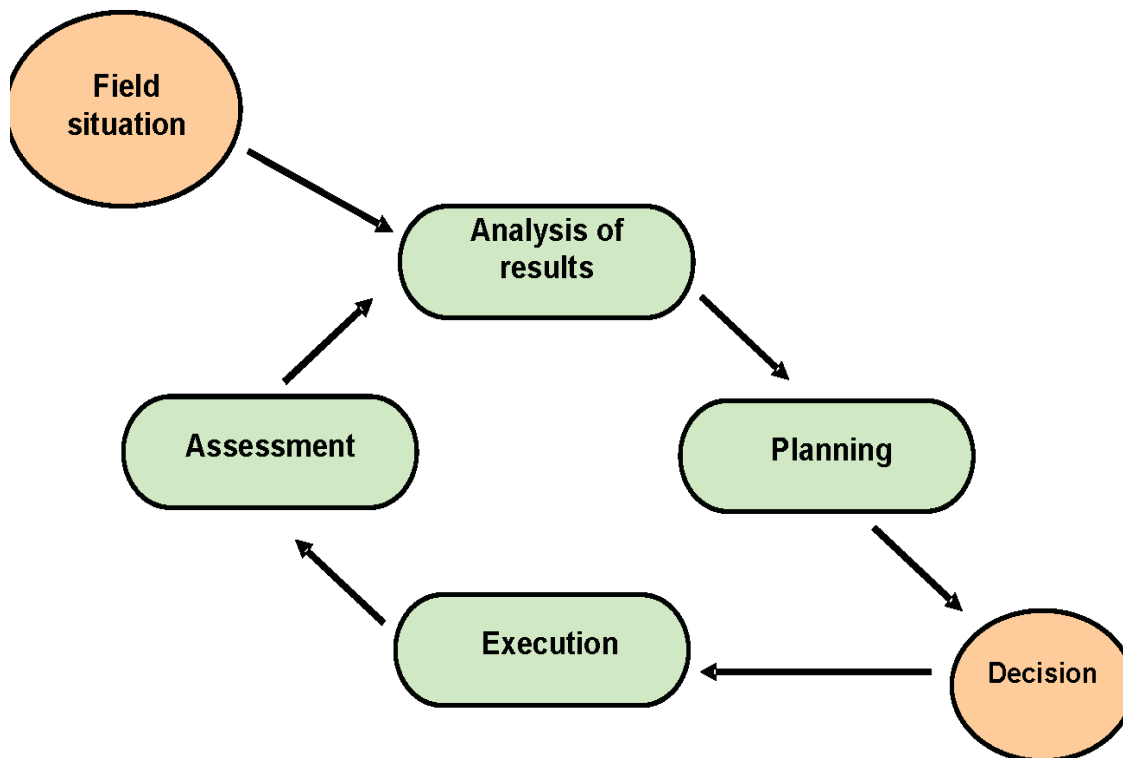

This process can be easily described, but it is very important because it is the basis for the staffs' reorganization that is to be speaking about in the next section.

3. The reorganization of an operational staff for the implementation of EBAO doctrine

As stated in the previous section, the EBAO doctrine has been developed firstly at operational level. Similarly to any new doctrine, it has organizational consequences. As to EBAO, the consequences are much deeper than other doctrinal changes because EBAO generates not only changes in the planning process, but also changes in the whole philosophy of operations. New needs had been identified, as well as elements that seemingly are redundant and may be eliminated.

But to reveal this new challenge, NATO decided to change the entire traditional structure of the operational staffs and left the „J” structure for a new structure consisting of three directorates with more offices. Besides the three directorates, the previous command group structure³², advisors³³ and administrative support³⁴ is more or less the same even if some names has been changed and a few positions have been established³⁵. Actually, the three directorates are connected to the thinking process:

3. 1. Knowledge Management Directorate

Given that EBAO doctrine is based on the analysis of systems of systems, entailing an as complete as possible knowledge of the adversary and the environment, a Knowledge Management Directorate is created. Its role is to guide knowledge

management that is to define a holistic and systemic view of the entire environment called “engagement space”³⁶ to support planning, execution and assessment for the entire staff. To this purpose, the Knowledge Management Directorate is, first

of all, responsible for the collection and utilization of the information from all sources (information of military interest as well as open source data about the engagement space) and for making the processed data available for other directorates.

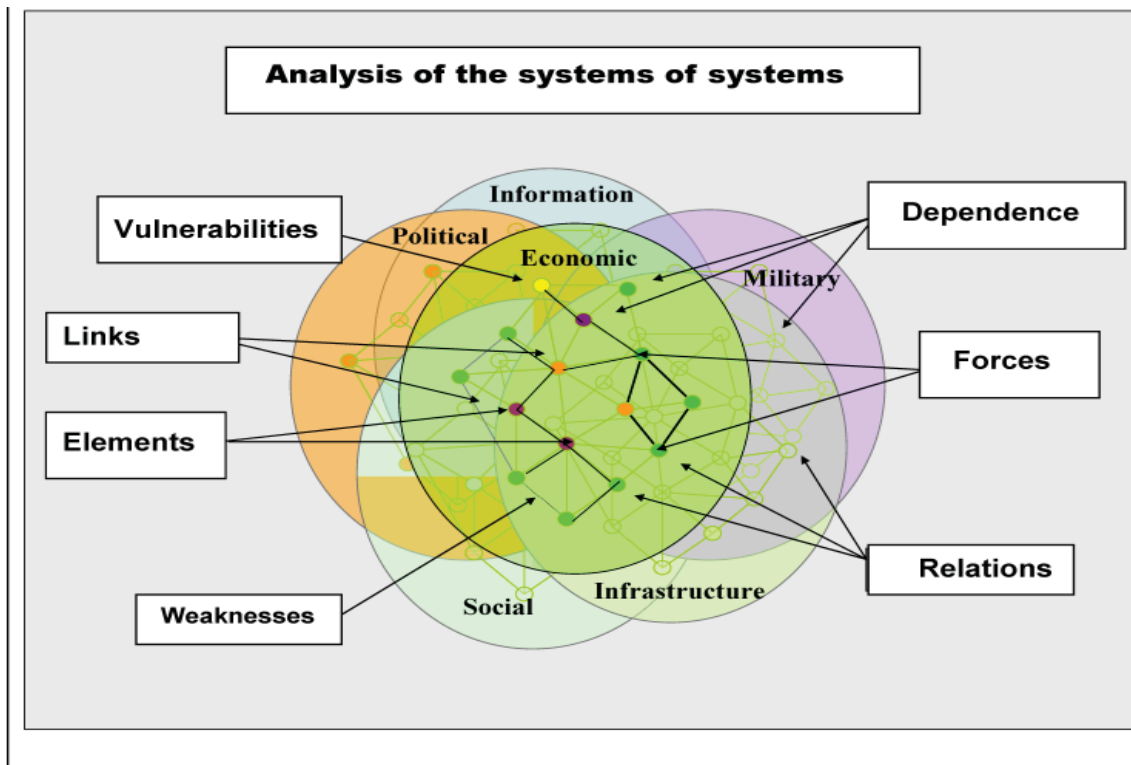

Then, the Directorate implements the method of analysis on systems of systems in order to identify the links, interactions, relations, dependence, strength, weakness and vulnerability of their elements in order to extrapolate the challenging points susceptible to maximize their own effects.

By its role in collection, use and processing of information, the Knowledge Management Directorate has a key role in the decision-making cycle, as it can be seen in the chart below³⁷:

In order to perform the process, the Knowledge Management Directorate is organized in three components: the core of the Directorate called Knowledge Centre Branch (KCB)³⁸, which is in charge with data collection and processing, one Exercise and Preparation Branch (EPB)³⁹ and one Joint Policy Application & Lessons Identified/Learned Branch (JPALLB)⁴⁰ responsible for dissemination of news and improvement of process efficiency.

3. 2. Resources and Operations Directorates (OD)

The second structure is called the Operations Directorate⁴¹. As it is indicated by its name, its objective is to conceive, develop, manage and start planning. In fact, unlike the knowledge concept, which is almost entirely new, the planning is not basically changed, even if the implementation and effect assessment change at a certain degree the former structure. Therefore, it is not necessary to develop the process of work as in the case of the previous Directorate: it involves only the functional adjustment of assessment/management described above. It is worth paying attention to the internal organization: in order to use the cycle of planning – decision-making – execution – assessment – result analysis described at the end of the previous part, the Directorate is divided in five elements (Joint Effect Management Branch, Joint Plans Branch, Joint Synchronization and Execution Branch, Joint Assessment Branch and Situation Centre) which,

using the information provided by the Knowledge Management Directorate, are present from the beginning to the end of the cycle.

The Joint Effect Management Branch will be to check if the effects⁴² obtained by forces are consistent with the political, economic and civil aims. It will operate in close cooperation with military and non-military actors in order to facilitate the operation execution. Also, it will ensure consistency at the level of the strategic communication and it will guide the function of reconstruction and development of the economy in the theatre⁴³.

The Joint Plans Branch⁴⁴ will guide the operational planning process and its duty will be to develop and adjust the campaign plans, operational plans and others⁴⁵. It will be comprised of staff officers with planning expertise (former J3/J5) as well as experts in other areas (intelligence, logistics, governing, construction, communication systems) meant to improve planning in their area.

The Joint Synchronization and Execution Branch⁴⁶ will coordinate and synchronize

adjustment of the plan and execution by the forces and other actors. Also, it will have the task to issue and coordinate orders and prepare specific products for the command.

The Joint Assessment Branch⁴⁷ will prepare, coordinate and manage the effect assessment process which is under the authority of the commander, in order to measure the progress toward the assumed final aim. He will suggest changes and improvements if they are needed.

Finally, the Situation Centre⁴⁸ will ensure a uninterrupted flow of information on the situation in the entire engagement space. He will be the main point for the exchange of information between the JFC and the theatre and the first level of assessment, choosing the appropriate information for the assessment preparation.

The third structure is called the Resources Directorate⁴⁹. It includes all services and offices needed to support operational activities: J1 (human resources), J4 (logistics), J6 (IT systems), J8 (finances), J ENG (infrastructure) and medical office.

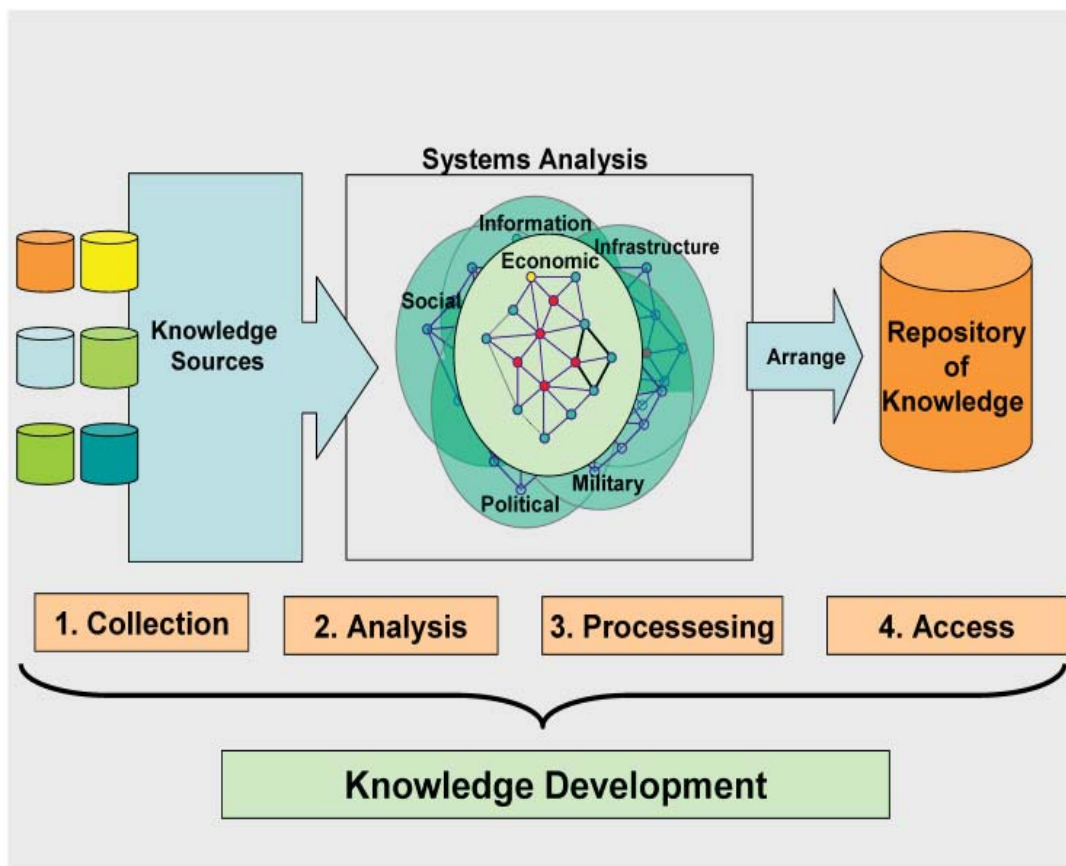



Given that the subordinated offices and services have functions similar to the former J offices, it is not necessary to develop explanations. The only (obvious) new thing about the J traditional structure is their regrouping under an intermediate command (Resources Directorate) but in JFCB as well as the American divisions, at least, that evolution was surpassed by the creation of a Deputy Chief of Staff Support⁵⁰ and the new organization will not change too much the current functioning way.

3. 3. General Structure

The chart below describes the future EBAO of a Staff at operational level that is JFCB.

Obviously, the organization fundamentally changed the Staff operation and development of an entire set⁵¹ of procedures was required which are now tested and which will be permanently (theoretically at least) adjusted to the reality and operational needs.

JFC HQ Brunssum Future Structure

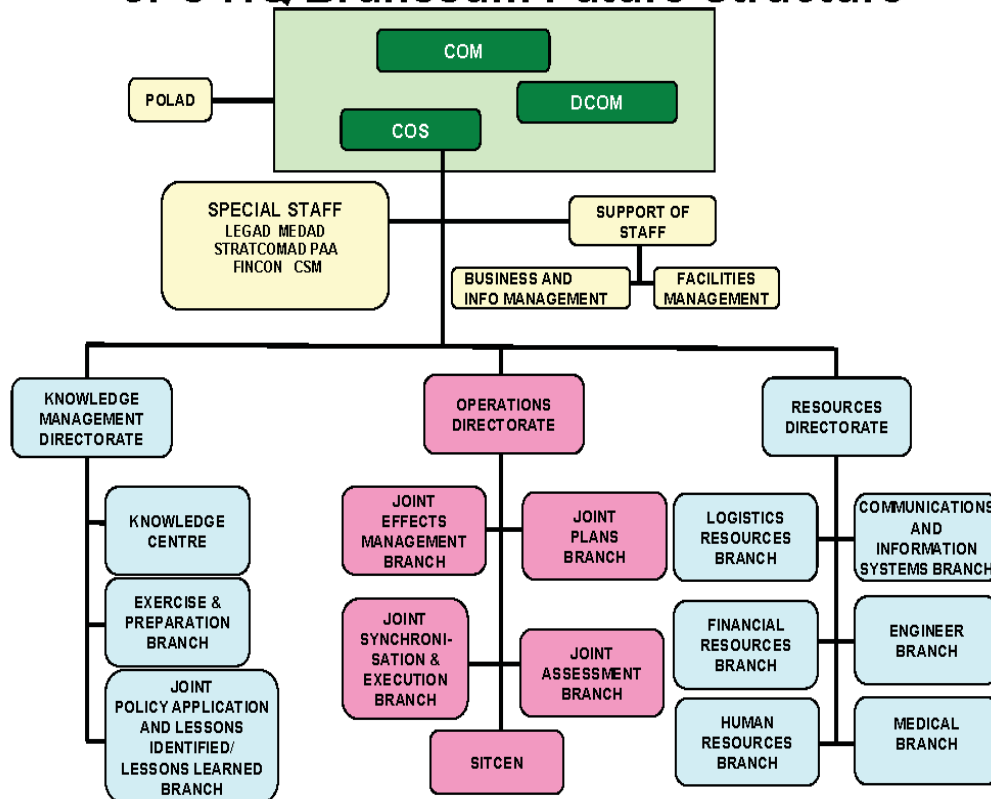

4. EBAO doctrinal risk and its operational consequences

As shown above, EBAO doctrine application to the functioning of NATO Operational Staffs has major organizational consequences. Its repository also includes some interrogations that worth be answered in the future. After investing tens of billion of dollars in EBO doctrine development and its requirements, USJFCOM reverted to its steps and suggested a “return to the principles and well-known terms which were validated during combat by our forces and firmly anchored in the

(traditional) theory and war nature⁵²”. NATO EBAO is not for sure American EBO and it seemed to have corrected the main deficiencies⁵³ but the warning is still significant.

As in any other doctrine, a risk exists when it is confronted with the facts. In EBAO/EBO doctrine families, that risk is increased by four factors: first, it is about extremely theoretic doctrines, which are very difficult to transcribe in simple terms and effects and actions that can be understood by people in the field⁵⁴. Then, as it was mentioned in the first part, it is about doctrines stemming from US Air Force⁵⁵ strategic thinking



and therefore it is an application that might not be optimum in crisis management operations for the most of land forces, in front of an unconventional adversary, operating in a complex environment and asymmetric operation methods. Moreover, this doctrine relies on the assumption that a perfect knowledge on the adversary and on other actors is possible, which it has to be proven. Finally, by their very analytical nature and profession of faith based on which the effects of our actions may be foreseen and measured not only when it comes to diminution but also when it comes to the change of the behaviour, EBAO/EBO doctrines lay a bet which, at least, is not won beforehand.

4.1.A doctrine too complicated to be easily implemented

A first weakness of EBAO, even in its simplified NATO version, is its abstraction and complexity. It is of course about a doctrine with operational and strategic vocation before it extends to the tactical area⁵⁶ and its finalization is not meant to be simple but even so it has to be intelligible for those implementing it to tactic level so that they are able to consciously use it. Or, the too theoretical vision of EBAO brought about the use of several concepts which are not easy to use by the minds used with clear order frameworks⁵⁷.

The first concept, difficult to catch, is that of effect. It is not about implementation, it is about obtaining an effect, in fact a “parcel” of an objective, showed by the changes taking place in the target⁵⁸ capacities and behaviour. If the consistency of the political level, the assumed final aim, objectives and actions/tasks is a legitimate concern inherited from the lessons of the past,⁵⁹ the introduction of an intermediary level means nothing else than an useless complication of the planning process and leads to an “unclear” planning resulting in “vague and obscure⁶⁰” orders unlikely to bring success.

Therefore EBAO doctrine implementation at tactical level (and even its optimal exploitation by the staffs at the highest level) is very unlikely⁶¹ at least as long as an ambitious education and training work is not carried out; and that can be fulfilled only with all nations’ support. Opposition continues, very often for excellent reasons, making possible the emergence of the risk of a new gap, a doctrinal one this time, between the Allies⁶².

Also resorting to some too abstract terms often of civil origin means nothing else than making a

delayed (in the best case) or wrong (in the worst case) decision, which can have only bad effects on the mission. An analysis of the last conflict between Israel and Hezbollah says that “the terminology was too complicated, useless and it could not be understood by the thousands of officers assigned to apply it”⁶³. It would mean to offend Tsahal if we think that the NATO nations’ officers would do better, the more so as the Israelis debated in their own language; ... despite the fact that all cadres speak English at NATO, the *native speakers* are a minority: use of sophisticated concepts which are often far from national doctrines can do nothing else than diminish the understanding and efficiency of the staffs...

Finally and especially, the sophistication surpasses by far the terms in order to come closer to the definition stage of the engagement space systems. According to the classic interpretation, the things are relatively simple: starting with a *check list*, the factors influencing the operations are evaluated, as well as those which can intervene and be integrated if necessary and the other actors showing they have a role in the operation success. According to EBAO interpretation, the first difficulty is to *a priori* evaluate the multiple actors in the engagement space, then to model them as systems. The complexity consists in finding the right level of description: for instance we have to consider the nations contributing troops as an assembly to be as many differentiated actor as they are, we have to differentiate the public opinions... Finally, the list of systems which actions and interactions have to be analyzed is either too general to be optimized or so long that analysis effort is impossible or it takes too long to be put in practice, except for the cases in which early warnings are available or the situation stays very stable, which opposes to any efficient planning, at least at tactical level or even higher if situation develops rapidly. It has to be found a method for description level optimization, a method which will be for sure difficult to develop given that the current conflicts are more and more distinct from each other.

4.2. A limited application area

What is worse than terminology and its conceptual difficulty which might be compensated, if necessity emerges, by a better training of personnel, is the fact that even the doctrine origin



and nature generate difficulties. Being the result of the reflections inherited from the Cold War period, in the bosom of a strategic culture marked by technology and developed by the air forces and based on targeting, EBAO doctrine, even made human and updated by NATO, still has, in my opinion, a limited application. Opposing the opinion of USJFCOM chief who asked the experiment to be stopped, Mr. William F. Andrews and Colonel Paul M. Carpenter, both of them coming from US Air Force are entitled to point out that the contributions of effects based operations have been confirmed by facts⁶⁴, but they avoid to explain that it is about a particular use: the initial stage⁶⁵ of *Desert Storm* operations (Iraq 1990-1991) is, according to them⁶⁶, *Allied Force* (Kosovo 1999).

Even in the case of air force operations, the success is not sure. Thus in Vietnam War, the American strategies applied the principles of effects-based wars to North Vietnam with the hope to weaken adversary willpower to fight, in 1965-1966 (*Rolling Thunder* Operation) with the known effects: early 1967, the adversary was able to conduct Tet offensive with as much as 70,000 fighters. The same thing happened in Kosovo. The studies after the war showed that NATO hit more decoys than real targets⁶⁷. Also, President Milosevic surrendered in the end because of the threat of a land operation and not because of the air strikes. It was the same in Iraq, the air operations had a significant effect on Saddam Hussein forces but it is difficult to measure EBO doctrine contribution, which was in testing stage, compared to that of the overwhelming Western technology superiority⁶⁸. Finally, in Lebanon, the air offensive in 2006 was a fiasco acknowledged as such by the Israeli military authorities⁶⁹.

This method showed to be more difficult to adjust to the land operations given that the complexity of environment and adaptability oppose by their own nature to system of systems analysis so much praised by EBAO doctrine⁷⁰. Therefore, there is nothing to prove that the *Desert Storm* Operation was a successful one because it was considered through the (still blurred) prism of effects but it is true that the land operation was conceived in a classical way and the Coalition's technological superiority resulted in the disarray of the Iraqi forces who were inferior from that point of view. On the contrary, it is obvious that

the intended final effect of the Republican Guards destruction was not reached because, later, the Iraqi tanks could easily crush the rebellious movements of the ethnic minorities...

Especially, it is obvious that implementation of those methods in the asymmetrical wars, which the contemporary Western armies are generally involved in, is less indicated, even counter-productive⁷¹, whether they are of state⁷² origin or not. The Israeli experience as far as *Hezbollah* is concerned shows very well the limits of EBAO doctrines applied to an enemy organized in network and operating in an asymmetrical way. The experiences in Iraq and Afghanistan show the difficulty of their application against insurgency which is an art which adjusts very little to the systematic approach so much praised by EBAO⁷³. On the other hand, the temptation to apply the rational analysis plan to the asymmetrical fighters leads very often to their underestimation – and to overestimation of our effects as far as they are concerned – which results in a cross-section vision of the operational situation.

4. 3. *Unattainable dream of engagement space perfect knowledge*

Another significant obstacle is the pretension to hold an almost perfect knowledge of the adversary and to a smaller extent of the actors and the environment. Certainly, even from the time of Sun Tzu, information on the adversary and other factors that influence the battle is constant, but the vocation of a perfect knowledge or of the “illusion of a perfect knowledge (...) seems very dangerous in itself⁷⁴”. Indeed, if it is possible to know almost conveniently a simple system within the conventional operations and especially for the air strikes⁷⁵, or to infer which are the weak point in a energy or communication supply network, then it is impossible to model complex systems adjusted to a decentralized guerilla and thus to identify the points where the effects should be applied.

Besides, the confidence in a perfect assessment on the adversary's vulnerabilities leads to the illusion that a selective war can be fought by targeting only the adversary's key points. Nevertheless, the fundamental principle of the use of less force and violence in favour of targeting points or individuals that are considered decisive it may seem an enticing media and humanitarian plan but it is also an impediment for the results



and leads to the oblivion of the importance of physical suppression in the adversary⁷⁶. This allows the adversary not only to keep his strength and means but also to decrease the morale of friendly forces. All together, if EBAO doctrine may be an enticing alternative to the wane when it comes about paralyzing a rigid system, then it proves its ineffectiveness in front of the unofficial and redundant networks.

Finally, the inevitable lack of information can lead either to fallacious analyses often generating bad decisions and civilian loses or to a paralysis of the action and this triggers abandonment in tactical-operational advantage by NATO and a loss of initiative to the benefit of the adversary⁷⁷.

The result of all these is that “the mist of war” if it is to use a famous formula by Clausewitz, is far from fading away. Despite the captors and increasingly sophisticated analysis techniques, the result of a combat action is influenced by too various and transient factors that leave too much room to chance.

4. 4. Determinism versus free will: the lesson of the history

Ultimately, the worst criticism that can be brought to EBAO doctrine is the extrapolation of the action effects on the adversary’s behaviour. Actually, the error is double: the former is related to the postulation only on the basis of complex systems: same actions will have the same consequences⁷⁸; the latter is to think that an action may trigger a predictable effect on the actors’ behaviour. Certainly, there are simpler cases when the effect does generate little doubt: any accidental bombing on the civilian population triggering significant damages, for instance, has only a negative impact on the local and international public opinion. But even in this tragic case the effects may be diversified⁷⁹.

Theoretically, this variety of effects for the same action and thus this corollary unpredictability of the effects can be easily depicted: it is enough to watch a chess game. The number of pieces is limited (20 for each player), the same is their movement, which is not the case for human systems. Nevertheless, this is enough to offer 40 opportunities for the first move, 400 following the first response of the adversary, 71,852 at the second strike and 315 billion following the fourth one⁸⁰! The so-called predictability offered by the

EBAO theories is a simple intellectual aberration that is pretty close through its nature to the old-fashioned scientific communism.

Besides the mathematical impossibility to predict everything, this double error stems from the reduction of adversary and of other actors into systems that are susceptible to react in a rational manner. In this regard, we lack a human vision which can be adjusted to the reality of the situation. Firstly, in the case of chess game mentioned above, each piece has a perfectly norm and limited ability of movement which is not evident in case of the persons who decide and even less in case of the networks characteristic to the modern guerrilla. Then, the effects that should modify behaviours are built on the supposition – or bet – that the actors/systems will react logically to these effects and this is unfortunately far from being the case all the times and it is less possible in case of asymmetric⁸¹ or even dissymmetric⁸² conflicts.

Moreover, by renouncing to massive physical results in order to offer privileges to the behavioural effects, the adversary’s freedom of strategic action is actually increased: during the preceding analysis the absence of physical destruction of all his means makes the adversary decide following the analysis of the balance costs/result if it is worth continuing the combat or if it is better to give up. If he decides to announce his defeat, he has also the opportunity to choose the appropriate moment to make this decision. Thus, he can adapt the calendar to the decision and may trigger prolonged operations. The behavioural primacy praised by the EBAO doctrine leads to the possibility to offer the adversary the opportunity to establish the calendar and achieve the major effect which is an increasing risk as the Western public opinion gets bored very soon and the adversary through his often displayed scorning of the human sufferings may accept a level of loses which is unimaginable for the Western armed forces⁸³.

It is far from being sure that the EBAO doctrine generates behavioural effects that it pretends to have been generating. Certainly, the EBAO flatterers have assimilated quickly the physical results of the operations as a proof of the impact on the adversary’s behaviour. This was the situation during the second and the third wars in the Gulf. Nevertheless, between 1990-1991 as well as in 2003, the Western victory was not the result of a behavioural change linked to the “feeling



of victory” of our forces and to the “feeling of defeat” inoculated to the adversary through the effects⁸⁴, but, as proven by the statements of the Iraqi military representatives it was the extraordinary military material and technology superiority of the aggressor that made impossible any attempt of symmetric resistance. Furthermore, the lasting resistance of the Palestinian, Iraqi and Afghan guerrilla proves in a clear manner that the insurgents’ will to fight remains intact, similarly to that of the British against the German *blitzkrieg* in 1940 or of the Germans against the strategic bombings at the end of WW II.

Conclusion: in quest of an optimum balance

Are those narrated in the above sections enough to condemn the EBAO method? On no occasion, but this allows a more nuanced image on the EBAO and makes us remember which deficiencies we should avoid. As in any doctrine, EBAO presents negative and positive points. Thus, it is not about NATO’s counting what is pro and what is con: the doctrine has already been validated: it is about its adjustment and making survive in order to maximize positive aspects and minimize and if possible eliminate the negative ones. The flexibility of the concept since it has not been halted yet except for the pre-doctrinal level allows indeed considering it an intelligent application that can let the extraction of the quintessence without being baffled by the doctrinal twines or being forced by the deficiencies of the classic EBO.

Among the positive points that should be favoured, the most interesting approach is without doubt to take into account a vast engagement space coming from the *Comprehensive Approach* that allows the projection of a series of concepts connected to planning and which so far has been often neglected or forgotten (political, economic, civilian level, other actors ...). Similarly, if the effect concept may be simplified, then it can be conveniently utilized to pragmatically assess the results and effects induced by the achieved actions and to prevent serious application errors. It is also interesting to take into account the behavioral action of the effects only if we do not want to be covered by the illusion of their so-called pragmatic nature, but to reinstate the human factor and his free will at the core of the issue. Finally, the analysis of the system has a certain

contribution to the neutralization of the physical networks, destruction of infrastructure; air strikes, high intensity classic fights and it should be better tailored to the asymmetric conflicts only if it is adjusted to such realities.

The negative points have been already pointed out and thus it is useless to resume them once again. It is worth mentioning that even if the doctrine is not improved indeed, its intelligent utilization is still possible and this might reimburse the lacks we talked about in the above sections. Even if some analysts do not agree with this idea, war remains an art and as General Sherman said „any attempt to make the war easier or safer will lead to humiliation and disaster”. Irrespective of the developed technology progress and analysis procedures, the mist of war will never fade out completely. The friction will remain always but it can be decreased more or less depending on the context, but it will never be possible to oust it completely. It is recommendable to make use of the positive aspects of the EBAO such as the integration of the *Comprehensive approach* and the rational analysis of various factors in the engagement space without being deluded by the contribution of the doctrine: EBAO is not a martingale that allows the replacement of the art of war through a science of battle; it is just an instrument among others to reduce friction, a method that should be used only when necessary, keeping in mind the following axiom: the war is through its nature and cruelty a human activity; then, the man has to, from the commander to the last soldier, decide the fate of the weapons, supported more or less by his technology, by his experience and skills ... and man will never refrain himself from building an equation.

REFERENCES:

BUMBĂCEA, Liviu, (colonel), *NATO Transformation and Enlargement*, on NATO Internet site, 2005.

CARPENTER, Paul M., (colonel USAF) și ANDREWS, William F., (USAF), “Effects-based operations combat proven”, in *Issue*, nr. 52, first quarter 2009, pp. 78-81.

COQUET, Philippe, (Captain), “Opérations basées sur les effets: rationalité et réalité”, in *Focus Stratégique*, no. 1, Paris, Institut Français de Relations Internationales (IFRI), October 2007.



COUTEAU-BÉGARIE, Hervé, **Traité de stratégie**, Economica, Paris, 2003.

CURTENAZ, Sylvain, “Effects-based... what?”, in *Military Power Revue der Schweizer Armee*, no. 2/2008, pp. 21-28.

ENE, Vasile, (Lieutenant Colonel, PhD), „Resursele succesului, Operațiile bazate pe Efecte, o provocare pentru arta militară contemporană”, in *Curierul armatei*, no. 18, March 30, 2009.

FRUNZETI, Teodor, (Brigadier General, PhD), De la asimetrie la idiosincrazie în acțiunile militare”, in *Strategic Monitor*, no. 1/2003, pp. 11-26.

HUNERWADEL, J. P., (USAF Lieutenant Colonel), “The Effects-Based Approach to Operations, Questions and Answers”, in *Air and Space Power Journal*, March 2006.

Joint Warfighting Center, “An Effects-Based Approach”, in *Issue* no. 44, first quarter 2007.

Kari PIETILÄINEN, Jukka NURMI, “The Effects Based Approach to Operations (EBAO)”, in *Tiede Ja Ase*, Volume 66, 2008.

KEEGAN, John, **L’art du commandement**, Perrin, Paris, 1991.

Collective paper, **Effects Based Approach to Operations, Bi-Strategic Command Pre-Doctrinal Handbook**, SHAPE/ACT, December 4th, 2007.

MATTIS, N. James, (General), *USJFCOM Commander’s Guidance for Effects-Based Operations*, on Internet site Government Industry, October 2008.

MIDAN, Christophe, **Roumanie 1944-1975, de l’armée royale à l’armée du peuple tout entier**, L’Harmattan, Paris, 2005.

SMITH-WINDSOR, Brooke, „Hasten slowly, NATO’s Effects Based and Comprehensive Approach to Operations”, Research Paper, *NATO Defence College*, Roma, no. 38, July 2008.

SUN Tsu, **L’art de la guerre**, Flammarion, Paris, 1963.

TOFFLER, Alvin and Heidi, **Guerre et contre-guerre**, Fayard, New-York / Paris, 1993 / 1994.

VACCINO, G., (general-maior), “The Age of EBAO”, in *Northern Star*, April 2009.

VEGO, Milan, (dr.), “Effect-Based Operations: a Critique”, in *Issue*, no. 41, second quarter 2006, pp. 51-57.

Idem, *Effects-Based Warfare: A Critical View*, Baltic Warfare College, September 2008.

VON CLAUSEWITZ, **De la guerre**, Paris, 1955.

WILLIAMS, Tim, “The Road to Riga & the Path Ahead”, in *Royal United Service Institute for European Security Programme Papers*, London, 2006.

NOTES:

¹ *EBAO: Effects Based Approach to Operations*, NATO term for the American Doctrine Effects-Based Operations (EBO). I will make use of this translation that is appropriate for both EBAO and EBO.

² *ACT: Allied Command Transformation*. This command is run by the French General Stephane Abrial since September.

³ ACT is in charge with research, doctrine, concept development, and appropriate rethinking on training. As its first American commander Giambastiani stated, “it should be the intellectual core for the transformation of the Alliance”.

⁴ US Joint Force Command that develops the joint doctrine for the American armed forces.

⁵ EBO/EBAO Doctrine was used in particular during the operations in Kosovo in 1999, in Iraq and Afghanistan after 2001 and by the Israelis in operations performed against Hamas and Hezbollah.

⁶ Joint Force Command Brunssum (JFCB) and Naples (JFCN) and Joint Command Lisbon (JFL).

⁷ Kari PIETILÄINEN, Jukka NURMI, “The Effects Based Approach to Operations (EBAO)”, in *Tiede Ja Ase*, Volume 66, 2008, pp. 1-2.

⁸ Vego, Milan, (dr.), *Effects-Based Warfare: A Critical View*, Baltic Warfare College, September 2008, p. 12.

⁹ HUNERWADEL, J. P., (Lieutenant Colonel USAF), “The Effects-Based Approach to Operations, Questions and Answers”, in *Air and Space Power Journal*, March 2006, p. 2.

¹⁰ COQUET, Philippe, (Captain), “Opérations basées sur les effets: rationalité et réalité”, in *Focus Stratégique*, no. 1, Paris, Institut Français de Relations Internationales (IFRI), October 2007, pp. 11-13.

¹¹ See, for instance, on Alexander the Great: KEEGAN, John, **L’art du commandement**, Paris, Perrin, 1991 or, on Caius Cezar, G. VACCINO (Major General), “The Age of EBAO”, in *Northern Star*, April 2009, pp. 3-4.

¹² Tactical School of the Air Corps.

¹³ Short term disturbance of the Nazi war machine by destroying several sectors such as the plants producing synthetic fuel or bearing and limitation in adversary’s offensive power through lack of fuel, decrease in strategic mobility through attacks against the railroad network.

¹⁴ COQUET, Philippe, op. cit., pp. 11-13 and VEGO, Milan, op. cit., pp. 12-13 and 21-26.



¹⁵ The actions performed in 1973 and 1982 that integrated classic and effects-based operations ended successfully for the Israelis.

¹⁶ According to Colonel Warden, the adversary may be described as a system of systems consisting of five parts or rings: leadership, organic essentials, infrastructure, population, fielded forces. VEGO, Milan, op. cit., p. 13.

¹⁷ Hunerwadel, op. cit., p. 2 and the following.

¹⁸ DIME: *Diplomatic, information, military and economic assets* or “diplomatic, information, military and economic tools”.

¹⁹ Or “Comprehensive approach manner”, taking into account not only the military instruments, but also the diplomatic, economic, political ones, in order to achieve the desired effect.

²⁰ Even if the difference between the two names does not appear at the first sight, to speak about “Effect Based Approach to Operations (EBAO)” and not about “Effects-Based Operations (EBO)” indicates that NATO prefers an “effects-based approach to operations” instead of a more exclusive doctrine for “effects-based operations”. ENE, Vasile (Lieutenant Colonel, Ph.D.), „Resursele succesului, Operațiile bazate pe Efecte, o provocare pentru arta militară contemporană”, in *Curierul armatei*, no. 18, March, 30th, 2009.

²¹ Collective paper, **Effects Based Approach to Operations, Bi-Strategic Command Pre-Doctrinal Handbook**, SHAPE/ACT, 4 December 2007, henceforth called *EBAO Handbook*.

²² **Knowledge Development Handbook, Assessment Handbook, EBAO Handbook and Guideline for Operations Planning**. All these documents are expected to be published in early 2010.

²³ For instance, if we consider the adversary as a system, by striking his air defence assets (sub-system “forces” sub-sub-system “air defence assets”) may have effects on the overall sub-system of “forces” (incapacity to conduct operations under appropriate safe conditions), or/and army morale (also a sub-system of “forces”) or another sub-system (sub-system “leadership”) which fears for its safety.

²⁴ For instance, an air attack against an enemy position (“enemy” system, sub-system of „forces” which results in civilian victims may have a negative effect on the system of the “United Nations” or on the “international community”.

²⁵ System of Systems Analysis.

²⁶ This basic data have been synthesized by NATO into six principles which are: EBAO is a philosophy additional to other philosophies such as “Indirect approach manner”; it is focused on the assumed end state and on the fact that effects should be created to influence the key actors’ behaviour or capabilities, with the purpose to achieve this objective; considers the environment as a system in which all actors and elements

interact to generate effects; makes use of the systems’ analysis to understand the relations between actions and effects; needs a harmonization in the contribution of various instruments of the Alliance; involves a continuous assessment of the actions’ effectiveness and their adjustment if necessary.

²⁷ **EBAO Handbook**, op. cit., pp. 1-2.

²⁸ Measures of Effectiveness or MoE.

²⁹ Measures of Performance or MoP.

³⁰ Source: **EBAO Handbook**, op. cit., p.F2.

³¹ Ibidem.

³² Command group. It encompasses the commander (COM), the deputy commander (DCOM), the chief of staff (COS) and it is directly subordinated to the political advisor (POLAD).

³³ Special Staff: legal advisor (LEGAD), medical advisor (MEDAD), press advisor (PAA).

³⁴ Support of Staff.

³⁵ A strategic communication advisor (STRATCOMAD), a financial advisor (FINCON) and a special operations advisor (SOFAD).

³⁶ On one hand, that engagement space is not only a physical and human environment itself (topography, key points of the terrain, population...) but also it includes all the actors in the field (enemy, allies, NGOs, security private societies, militias, local administration, priests, tribes...) and governmental/non-governmental actors located outside the theatre but with effect (at least a potential one) on the crisis. On the other hand, that engagement space is not limited to the military analysis of the environment/actors; it takes into account the political, economic and civil dimensions of the crisis as well as the assumed international aim and the social elements, infrastructure and the area of information and communication.

³⁷ Source: **EBAO Handbook**, op. cit., pp. 3-2 and 3-4.

³⁸ Knowledge Centre Branch (KCB).

³⁹ Exercise and Preparation Branch (EPB).

⁴⁰ Joint Policy Application & Lessons Identified/Learned Branch (JPALLB).

⁴¹ Operations Directorate (OD).

⁴² Joint Effect Management Branch (JEMB).

⁴³ CIMIC (Civil-Military Cooperation) and R&D (Reconstruction and Development).

⁴⁴ Joint Plans Branch (JPB).

⁴⁵ Campaign Plans, CONOPS, OPLAN, SUPLAN, Contingency Plans and Branch Plans.

⁴⁶ Joint Synchronization and Execution Branch (JSEB).

⁴⁷ Joint Assessment Branch (JAB).

⁴⁸ Situation Centre (SITCEN).

⁴⁹ Resources Directorate (RD).

⁵⁰ Deputy Chief of Staff Support (DCOS SUP).

⁵¹ SOP (Standard Operating Procedures) and SOI (Standard Operating Instructions).



⁵² MATTIS, N. James, (general), *USJFCOM Commander's Guidance for Effects-Based Operations*, on Internet site Government Industry, October 2008, uncounted pages.

⁵³ A too mathematical and determinist aspect and also the persistence on the plurality of actors and means of action.

⁵⁴ SMITH-WINDSOR, Brooke, "Hasten slowly, NATO's Effects Based and Comprehensive Approach to Operations", Research Paper, NATO Defence College, Rome, no. 38, July 2008, p. 3.

⁵⁵ HUNERWADEL, op. cit., pp. 2-3.

⁵⁶ COQUET Philippe, op. cit., pp. 2-3.

⁵⁷ Brooke SMITH-WINDSOR, op. cit., pp. 3-4.

⁵⁸ See the paragraph 2 above.

⁵⁹ HUNERWADEL, op. cit., p. 2.

⁶⁰ MATTIS, N. James, op. cit.

⁶¹ COQUET, Philippe, op. cit., pp. 8-10 and 19.

⁶² Brooke SMITH-WINDSOR, op. cit., pp. 3 and the following.

⁶³ MATTIS, N. James, op. cit.

⁶⁴ CARPENTER, Paul M., (USAF Colonel) and ANDREWS, William F., (USAF), „Effects-based operations combat proven”, in *Issue*, no. 52, first quarter 2009, pp. 78-81.

⁶⁵ Which is the classic *symmetric* phase in military operations and not the *asymmetric* one for stabilization and combat against insurrection.

⁶⁶ See the following footnote.

⁶⁷ During 58, 574 sorties in 78 days, only 14 tanks, 18 troop carriers, 20 artillery pieces and almost 20 airplanes would have been destroyed. The initial digits resulted from the immediate evaluation of loses were more significant (20 tanks, 220 carriers and 450 artillery pieces) and that proved the difficulty in obtaining a qualified assessment even on a symmetric operation in a limited theatre of operations.

⁶⁸ Plus Saddam Hussein's strategic errors and the passive position war tactics used by the Iraqis which was totally inappropriate to their obvious inferior position.

⁶⁹ MATTIS, N. James, op. cit.

⁷⁰ VEGO, Milan, (dr.), „Effect-Based Operations:

a Critique”, in *Issue*, no. 41, second quarter 2006, pp. 51-57.

⁷¹ See the following paragraph.

⁷² MIDAN, Christophe, (maior dr.), **Roumanie 1944-1975, de l'armée royale à l'armée du peuple tout entire**, Paris, L'Harmattan, 2005, pp. 164-169.

⁷³ COQUET, Philippe, op. cit., pp. 20-22 and VEGO, Milan, *op. cit.*, p. 26 and the following.

⁷⁴ COQUET, Philippe, op. cit., p. 20.

⁷⁵ Position and performance of the adversary air defence batteries, detection of CP and hard materials.

⁷⁶ VEGO, Milan, *op. cit.*, p. 12 and the following, and MATTIS, N. James, op. cit.

⁷⁷ Fortunately, the chiefs acting at tactical level are prompt in seizing all opportunities and this paralysis will remain more potential than real, as long as the cadres of NATO nations will be educated in an attitude of initiative.

⁷⁸ This conclusion stems from SOSA and it is true for the simple systems but it becomes at random as soon as the human factor is introduced.

⁷⁹ Such a tragedy would cause only few reactions because it may be occulted by other serious comparable facts which may intervene at the same time, other may cause an official reaction of certain actors when the same facts would have not triggered any action a few weeks before. Such an action might trigger population's solidarity with the guerrilla or, on the contrary, forbid its members melting among the population for fear some events might reoccur.

⁸⁰ VEGO, Milan, *op. cit.*, p. 18.

⁸¹ Ibidem, p. 18 and the following.

⁸² See the *a priori* aberrant reaction of Saddam Hussein in attacking Israel during the Second War in the Gulf.

⁸³ VEGO, Milan, *op. cit.*, pp. 14 and 17 and the following.

⁸⁴ COQUET, op. cit., pp. 20-22, MATTIS, N. James, op. cit., and VEGO, Milan, *op. cit.*, pp. 18-19.

Lieutenant Colonel Christophe MIDAN (christophe.midan@fcbs.nato.int) is a political adviser within JFC Brunssum, the Netherlands.



HUMAN SECURITY AND THE PHRASE “PARTNERSHIP FOR SECURITY” FOR NATO’S STRATEGIC CONCEPT

Paul DUȚĂ, PhD

In 2010, NATO will issue a new strategic concept.

After the fall of the “Berlin Wall”, NATO Strategic Concept dilute, conceptual and factual, the size of defense – in the development paradigm “security through cooperation”.

The challenges of the early 21st century require NATO to re-order the political-military options and security in a New Strategic Concept, which essentially is symbolized by the Romanian proposal of phrase “Partnership for Security” as an answer the prospective line of holistic development of “security through cooperation”.

The Romanian proposal for the NATO strategic concept – “Partnership for security” –must take into account the human security concept.

Human security is still an emerging paradigm for understanding global vulnerabilities whose proponents challenge the traditional notion of global, regional, and national security. The main argument is that the proper referent for security should be the individual rather than the state or alliance.

NATO could act in Africa as a mobile peace building or extraction force supporting an AU or UN mission is the most credible and convenient scenario.

Keywords: NATO, strategic concept, human security,

NATO’s Strategic Concept is designed to provide the political and military background for the alliance strategy. It also provides guidance to alliance military authorities on how to implement that strategy. Originally classified, the concept became a public document when last updated in 1991¹.

NATO’s new Strategic Concept is responsive to changes in the Euro-Atlantic security environment, focused on the following key elements²:

- Collective Defense: The Strategic Concept underscores the enduring core mission of NATO as the collective defense of its members under Article 5 of the North Atlantic Treaty.

- Military Capabilities: The Concept reaffirms Allies’ determination to strengthen Alliance defense capabilities by ensuring forces that are more mobile, sustainable, survivable and able to engage effectively on the full spectrum of NATO missions³.

- New Missions: The Concept calls for improvements in NATO’s capability to undertake new missions to respond to a broad spectrum of possible threats to Alliance common interests, including: regional conflicts, such as in Kosovo and Bosnia; the proliferation of weapons of mass destruction and their means of delivery; and transnational threats like terrorism⁴.

- New Members: The Concept underscores NATO’s continued openness to new members and Allies’ commitment to enlargement as part of a broader effort to enhance peace and stability throughout the Euro-Atlantic community.

- Strengthened Partnerships: The Concept reinforces Alliance efforts to build wide-ranging partnerships with the aim of increasing transparency and mutual confidence in security matters and enhancing the capacity of allies and partners to act together.

- European Capabilities: The Concept highlights development of a European Security and Defense Identity within NATO as an essential element of NATO’s ongoing adaptation, enabling European allies to make a more effective contribution to Euro-Atlantic security.

The political role of NATO does not collect one unified position within the Alliance – most experts and politicians argue that NATO should take a broad approach. Some say that it should concentrate on purely military issues, and leaving



more political ones to other organizations such as the EU. As a result, there is no real debate within NATO on today's truly strategic issues, such as Iran or the Middle East crisis. The place of NATO in transatlantic relations is not certain⁵.

Most scholars argue that NATO needs a New Strategic Concept, but there has been no real, even informal, discussion on this within the Alliance. Some member states perceive possible debate on a new strategy as an opening of Pandora's Box. They think it would bring new divisions and tensions instead of clarity over NATO's long term objectives.⁶

One of the main questions for the new strategic concept is - Can NATO become a truly global organization? Is there a political will? Is there a public support for this? It seems to me that the answer is that NATO could, and is, indeed, engaging in worldwide operations, but it should be done very selectively, only in those cases when we can bring added value. The mission in Afghanistan is one such operation and of course it is crucial to the credibility of the Alliance. Failure in Afghanistan would not only damage NATO as such, but it would strike a blow to multilateralism. It would show that the only choice left in a situation of a real crisis outside the Euro-Atlantic area would be between unilateral action by nation states or no action at all.⁷

The notion of a New Strategic Concept (NSC) raised some disquiet because overwhelming preference was for the maintenance of the traditional role of the Alliance - 'collective defense' as defined by Article 5 of the Washington Treaty. In contrast, some others argued that it is a mistake to see a NSC as potentially undermining NATO's defensive role. Whilst current discussions indicate that a NSC would be likely to emphasize expeditionary tasks and broaden the geographical scope of NATO operations (an option advocated by the US) such an evolution is, it was argued, necessary if the Alliance is to remain relevant to today's volatile environment⁸.

An area that causes transatlantic misunderstandings is that of the worldwide security. The first decade of the 21st century is dominated by the attempts of certain countries to obtain control of the global agenda through the various and evasive challenges: the terrorism of the radical *Jihadist* groups and the proliferation of weapons of mass destructions. On the background

of Iranian policy in the field, it is difficult to predict how many countries will become nuclear powers by 2025, the dissolution of the States⁹.

Almost one quarter of the 200 countries of the world don't have their own governance capacity; most of the people of these countries are forced to live in precarious living conditions, differentiated and unequal access to the resources. From this point of view, analysts are placing China on the first place among the stocks resources of the future, being already registered long-term agreements with Iran and Sudan for oil and other African countries for raw materials. Russia, through the huge resources of oil and gas which it possesses, it reaffirms as the world power, making use of this advantage to achieve its own interests. Russia and China, together with the states of Central Asia, recently formed a regional organization (the Organization for Cooperation in Shanghai), without mentioning if that was based on military reasons and / or economic.¹⁰

Establishing NATO as a global player should be a crucial element of the new strategic concept. Transatlantic security interests reach beyond Europe's borders, and NATO needs to play a more dynamic role on the international stage. However, the Afghanistan mission has revealed the profound lack of political will on the part of some NATO members to undertake this role and to assume an equitable share of the burden. NATO is already showing danger signs of turning into a two-tier alliance. NATO should be a defense alliance against all threats, regardless of origin, and act where it is necessary to defeat them¹¹.

NATO launched campaigns outside its traditional domain. Initially, the Alliance was meant to block the expansion of the communist influence, and to defend the Western Europe.¹² The geographical area of its mission was clearly set by the founders. But in post Cold-War Era, NATO openly got involved in wars in Bosnia-Herzegovina, Kosovo, Afghanistan, and assisted the African Union in enhancing the peacekeeping mission in Darfur. At the same time, the Alliance is playing a role in Iraqi's transition.

NATO built a global network of partnership programs. In order to extend its global influence, the Alliance shaped various partnership programs for different countries, as the Partnership for Peace, Mediterranean Dialogue, Istanbul Cooperation Initiative, etc. These programs help NATO's



“antennae” reach a big number of countries worldwide.

The Alliance is trying to transform itself into an almighty giant. “NATO was formed as a defensive military organization. But in real life it is acting against those initial objectives, as seen in the military operations in 1999 Kosovo War and the ongoing counterterrorist Afghanistan War. On the other side, NATO extends its fields of interest in many directions where other usual defensive organizations seldom get involved. An example the Alliance got involved in fields as climatic change, energy security, instruction and education programs, and other related fields.”¹³

During the Cold War, China was opposed to the US using NATO as a tool for the purpose of controlling Europe and intensifying competition with the Soviet Union for global supremacy. On the other hand, China was always sympathetic with the European allies for their position, expressing its understanding of the defensive strategy of NATO vis-à-vis the Soviet military pressure. With the end of the Cold War, China has voiced its opposition to the NATO military action tinged with strong ideological bias, aimed at interfering in other countries’ internal affairs without the authorization of the UN Security Council. However, the world is changing rapidly. Both China and NATO are in development and transition. Against this background, China now seems to begin accepting the positive role possibly played by NATO in international efforts for world and regional peace and stability. This leaves much room for enhancing cooperation between Beijing and NATO in the future.¹⁴

On NATO’s part, China’s growing economy and its rising influence in world affairs would also serve as a powerful incentive for Brussels to seek a new relationship with Beijing.¹⁵ Necessity becomes the mother of cooperation. “It can therefore be argued that the two sides will increasingly seek to cooperate where their interests overlap; to manage their differences where their interests don’t; and to avoid confrontation where their interests are in conflict”¹⁶.

The alliance should play a global role but will not be a global organization in the sense to expand and accept new members from outside the traditional transatlantic area.

First of all, confirmed by the 1999 Strategic Concept: threats at NATO security are no longer

local, regional and unidirectional, but global - even virtual global.

Secondly, because of the universal character of the promoted values, the Alliance has a moral duty to go beyond the traditional boundaries and to adopt a global perspective.¹⁷ NATO will not in any pure civil alliance, but it will need to combine its efforts with other organizations of civil status addressing the global security (comprehensive approach), in the complexity given by the network of participants to its maintaining (networked security).

The global approach to security or *holistic*, as it is also called, sees to employ a full range of potential missions that includes the full range of tension, the crisis prevention and humanitarian operations, and up to the operations which involve armed fight with high intensity.

Since the humanity started organizing itself in collaborative social groups, the notion of security arose and was developed, from the lowest individual scale, to the highest organizational level – that being the global security. For the most of the modern history was about confrontational disputes among states and alliances, the notions of national, regional, and global security have been very well-developed. Apart from being developed, the above mentioned notions were also translated into the national, regional and global political organizations’ means and ends.

Until the early 1990s, the human security issue was mostly left in the hands of the individual states and that proved to be the worst factor for the most of the Southern states’ citizens, as well as for those ones living in the Eastern European countries, just to give two brief examples.

The cover for the lack of what has been defined later on as being the human security was that the most of the states accomplished their share of regional and global security burden, while following their main objective – the national security. But what was inside the nice painted fences was something well known but ignored by the international community. That is just the proof that “moral considerations are not what guides state behaviour”¹⁸.

It took humanity the death of almost one million people in about one hundred days starting April 1994 to finally wake up and take a stand against the atrocities committed on innocent civilians. The Rwandan genocide (it took United



Nations Organization few months of debate on this term, that allowing the Hutu - Tutsi conflict to grow that big and monstrous) was and still is the most eloquent example of human rights and security abuse leading to national and regional instability, as we look at the unsolved situation in the Democratic Republic of Congo. But that was just the drop what made the humanity finally eager to put some kind of human security doctrine in place and follow up its implementation.

First, we have to admit that the human security definition has its roots few years before that. "The idea of human security is the glue that holds together a jumbled coalition of 'middle power' states, development agencies and NGOs, all of which seek to shift attention and resources away from conventional security issues and toward goals that have traditionally fallen under the rubric of international development."¹⁹

The collapse of the Soviet Union opened the Pandora's box for many countries to play the international politics game by themselves, following strictly individual agendas and having no moral limits on the burden and pressure they put on their own citizens. And that opened the eyes of the international media to make visible the realities of the most of the hard-hand ruled countries.

Starting 1994, the international organizations began to develop a concept of human security that has been receiving increasing attention in multilateral agencies. It is being transformed into a point of reference for the main global security trends of the twenty-first century. As a matter of fact, the 1994 Human Development Report by the United Nations Development Programme (UNDP) presented its analysis on new dimensions of human security and defined them based on two main components - freedom from fear and freedom from want.

The UNDP indicates that these two components form part of the origin and foundation of the United Nations. In this regard, it emphasizes that "the world can never be at peace unless people have security in their daily lives". The human security concept presented by the UNDP identified seven categories of threats that affect various spheres of action: economic security, food security, health security, environmental security, personal security, community security and political security.²⁰

Economic security requires an assured basic income for individuals, usually from productive

and remunerative work or, as a last resort, from a publicly financed safety net. In this sense, only about a quarter of the world's people are presently economically secure. While the economic security problem may be more serious in developing countries, concern also arises in developed countries as well. Unemployment problems constitute an important factor underlying political tensions and ethnic violence.

Food security requires that all people at all times have both physical and economic access to basic food. According to the United Nations (UN), the overall availability of food is not a problem; rather the poor distribution of food and a lack of purchasing power is often the problem. In the past, food security problems were dealt with at both national and global levels.

However, their impacts have been limited. According to UN, the key is to tackle the problems relating to access to assets, work and assured income (related to economic security).

Health Security aims to guarantee a minimum protection from diseases and unhealthy lifestyles. In developing countries, the major causes of death are infectious and parasitic diseases, which kill 17 million people annually. In industrialized countries, the major killers are diseases of the circulatory system, killing 5.5 million every year. According to the United Nations, in both developing and industrial countries, threats to health security are usually greater for poor people in rural areas, particularly children. This is mainly due to malnutrition and insufficient supply of medicine, clean water or other necessity for healthcare.

Environmental security aims to protect people from the short and long term ravages of nature, man-made threats in nature, and the deterioration of the natural environment. In developing countries, the lack of access to clean water resources is one of the greatest environmental threats. In industrial countries, one of the major threats is air pollution. Global warming, caused by the emission of greenhouse gases, is another environmental security issue.

Personal security aims to protect people from physical violence, whether from the state or external states, from violent individuals and sub-state actors, from domestic abuse, or from predatory adults. For many people, the greatest source of anxiety is crime, particularly violent one. Community security aims to protect people from



the loss of traditional relationships and values and from sectarian and ethnic violence. Traditional communities, particularly minority ethnic groups are often threatened. About half of the world's states have experienced some inter-ethnic strife. The United Nations declared 1993 the Year of Indigenous People in order to highlight the continuing vulnerability of the 300 million aboriginal people in 70 countries as they face a widening spiral of violence.

Political security is concerned with whether people live in a society that honours their basic human rights. Human rights violations are most frequent during periods of political unrest. Along with repressing individuals and groups, governments may try to exercise control over ideas and information.

The above mentioned report highlights the human security as being defined by two elements: "safety from such chronic threats as hunger, disease and repression [and] ... protection from sudden and hurtful disruptions in the patterns of daily life".²¹

The previous definition focused on the equal attention given to both *freedom from fear* as well as *freedom from want*, but due to further development and prioritization by the human security adepts, divisions have gradually emerged over the proper scope of that protection (e.g. over what threats individuals should be protected from) and over the appropriate mechanisms for responding to these threats.

The school of *freedom from fear* seeks to limit the practice of human security to protecting individuals from violent conflicts while recognizing that these violent threats are strongly associated with poverty, lack of state capacity and other forms of inequities. This approach argues that limiting the focus to violence is a realistic and manageable approach towards human security. Emergency assistance, conflict prevention and resolution, peacebuilding are the main concerns of this approach. However, whether such "narrow" approach can truly serve its purpose in guaranteeing more fruitful results remains to be an issue. For instance, the conflicts in Darfur are often used in questioning the effectiveness of the "Responsibility to Protect", a key component of the freedom from fear agenda.

The school of *freedom from want* advocates a holistic approach in achieving human security

and argues that the threat agenda should be broadened to include hunger, disease and natural disasters because they are inseparable concepts in addressing the root of human insecurity and they kill far more people than war, genocide and terrorism combined. Different from *freedom from fear*, it expands the focus beyond violence with emphasis on development and security goals. Despite their differences, these two approaches to human security can be considered complementary rather than contradictory. Although freedom from fear and freedom from want are the most commonly referred to categories of human security practice, an increasing number of alternative ideas continue to emerge on how to best practice human security.

More important than defining human security is recognizing how it is tied into other human or security centred issues. As this is a very broad area to cover, I will only touch the connections with the human rights, development, as well as traditional security.

It is a certainty and not a new idea that there is a connection between human security and human rights and dignity exists is certainly not a new idea. For example, the 1994 *Human Development Report* claims that human security is "a concern with human life and dignity"²² and the Commission on Human Security emphasizes that human security and human rights, far from competing notions, are in fact complementary.²³

According to the report *Human Security Now*, the relationship between the two concepts is best understood as mutually reinforcing, where "human security helps identify the rights at stake in a particular situation" and "human rights help answer the question how should human security be promoted?"²⁴ Human security is indebted to the human rights tradition.

The development of the human security model can be seen to have drawn upon ideas and concepts fundamental to the human rights tradition. Both approaches use the individual as the main reference and both argue that a wide range of issues (i.e. civil rights, cultural identity, access to education and healthcare) are fundamental to human dignity.

A major difference between the two models is in their approach to addressing threats to human dignity and survival. Whilst the human rights framework takes a legalistic approach, the human security framework, by utilizing a diverse range of actors, adopts flexible and issue-specific



approaches, which can operate at local, national or international levels.

The ethical and legal force of human rights claims strength, and it is strengthened by the “descriptive richness of the considerations that make security so important in human lives.”²⁵

Moreover, the human rights idea of claims and correlative duties gives some effectiveness to the perspective of human security in determining who has what obligations. It is obvious that human security is not just an argument about securing human rights. It is a concept that goes much further in its understanding, both about the potential sources of threat (or shear of) to these rights and about the conditions and kinds of institutions and governance arrangements (domestic as well as international) required to sustain human rights. While human rights cannot be perfectly identified with human security, human dignity is at the heart of both human rights and human security, the strongest link between the two concepts.

In addition, at a glance, the relationship between human security and development seems to be very simple to be summarized: if there is development, there is human security. But continuing conflicts and human rights abuses following the end of the Cold War and the fact that two-thirds of the global population seemed to have gained little from the economic gains of globalization, led to fundamental questions about the way development was practiced. It seems that that economic growth is insufficient to expand people’s choice or capabilities, especially in areas such as health, education, technology, the environment, and employment.

What is obvious is that the security and development are interconnected and one can easily present few factors of that. First, human security forms an important part of people’s well-being, and it is therefore an objective of development that enlarges the human choices.

On the opposite, insecurity cuts life short and thwarts the use of human potential, thereby affecting reaching this objective. Second, the lack of human security has adverse consequences on economic growth, and therefore on development, and we can see the price paid by all the countries affected by wars, where the development was completely stopped. Third, imbalanced development that involves horizontal inequalities is an important source of conflict. Therefore, vicious cycles of

lack of development which leads to conflict, then to lack of development, can readily emerge. Likewise, virtuous cycles are possible, with high levels of security leading to development, which further promotes security in return.

Moreover, the concept of security at the beginning of this century can be articulated based on relating the concepts of international security, state security and human security. To the extent that vulnerabilities and threats to international security increase, pressure will be put on states to take action in a context such as the one that we have defined, in which the state has less resources of real power. Also, interstate crises and conflicts affect human security and international stability. So, it is essential to achieve stability in interstate relations by demilitarizing the links.

Furthermore, human security demands are made on both the state and the international system. In international security, it is global aspects, interdependent markets and the weight of state actors, international organizations and non-state actors.

State security is classical security and involves aspects linked primarily to sovereignty and border issues. The weight of military forces and the balance of forces, as well as concepts associated with dissuasion and defence take place at this level.

The human security is at the lowest level, which addresses more local dimensions, although they involve large masses of humanity.

It also addresses global issues, such as environmental matters and pandemics. These types of issues are not traditionally approached at the other two levels of security. It is obvious that cooperation is beneficial, whilst insecurity at one of the three levels affects the other levels. Looking in detail at this aspect, human security can give greater cohesion to interaction between international security and state security. But there are also differences which individualize and make the delineation between the traditional and human security, those being the reference (*state versus people*), scope (*defend versus protect*), actor (*state versus a wide range of entities people-centred*), and means (*national power versus people*).

What makes the difference in the end of the day is what is taken into account: the commonalities, to get a common benefit, or the differences, to take apart the state from its people.



Above all, the most important for human security implementation is to define who the players are and what actions do they have to take.

The human security providers constitute a network of multiple actors, including the United Nations, international organizations - NATO, states, NGOs, and the empowered individual.

Even though the state's prerogative is to provide security for its people, and therefore its sovereignty, it is not always (or, in the most of the cases) a provider of security.

The democratic state remains the only truly legitimate actor on the international scene, because unlike representatives of the so-called civil society, NGOs or other groups, it represents the majority of people on a given territory, and this provides ultimate legitimacy. The state cannot be the only provider of human security because a number of states remain undemocratic, states can constitute the main threats to people's security, and some threats cannot be addressed at a national level only.

Many actors, at multiple levels, are required to address the threats that in the very same way can be local, national, regional or global. The strength of human security, which also constitutes a weakness, is its integrated and interdisciplinary nature, the actors work better within a framework of coordination and complementation.²⁶

The network lacks the cohesion, for actors' different conceptions of human security reflect partly, if not exclusively, their own interests, rather than the interest of the human being. Even their agenda is not completely different and selfish, nothing can be done, unless there is coordination among those involved in securing the human beings.

Looking at the actors' actions, it is always about intervention. The need for intervention, not necessarily military, comes from the "responsibility to use appropriate diplomatic, humanitarian and other peaceful means, in accordance with Chapters VI and VIII of the Charter, to help to protect populations from genocide, war crimes, ethnic cleansing and crimes against humanity. In this context, we are prepared to take collective action, in a timely and decisive manner, through the Security Council, in accordance with the Charter, including Chapter VII, on a case-by-case basis and in cooperation with relevant regional organizations as appropriate, should peaceful

means be inadequate and national authorities are manifestly failing to protect their populations from genocide, war crimes, ethnic cleansing and crimes against humanity."²⁷

The most well-known, military interventions are one of many forms of intervention under the human security banner, which favour largely non-military solutions to threats, ideally addressing root causes of tensions and conflicts before war or massacre ensues, which might then require military intervention.

If the prevention would have been a real focus, the "responsibility to protect" would never have to be enforced. The non-military solutions can and have to address all the areas in which the state is unable to fulfil its duties towards the citizens' well-being.

In brief, human security is not yet were the international community would like to have it, for there is still misunderstanding when it comes to the definition itself, there is still an on-going debate over the relationship with the traditional security and other people-centred issues, as well as there is neither cohesion amongst the actors involved nor unity of effort in their actions aimed at providing security to the most in urgent need human beings.

There is hope, for the issue is in debate, that the elaboration of NSC to analyze what is necessary for the future of NATO.

Nowadays, the general world's tendency is going categorically toward a globalization of the security, and each decision or action in political or military field generates reactions not only in that area, but even on other continents. Africa cannot stay out, the tendency of regionalization being a catalyst of the general trend.

At this moment, NATO is the most powerful security regional organization, not a global policeman, but interested in guaranteeing the Euro-Atlantic security by reducing or eradicating the challenges and the risks, that sometimes spread out over more continents.

Through cooperation with regional organizations, providing support for the peace-building and peacekeeping missions (non-article 5), NATO can contribute to a better world where the principles of democracy mix up with the wish for multilateral cooperation.

Regarding Africa, the NATO Secretary General affirmed: "We do not see ourselves as a global policeman, or, as the French would say,



'Le gendarme du monde'. We are not seeking to impose ourselves, nor do we pretend that we have the answers to all of Africa's security problems. That is why we strongly support the principle of African ownership. And that is why we will always coordinate closely with other international organizations – especially the United Nations. We need African solutions for African problems."²⁸

The unstable situation on African continent has been generating insecurity inside and outside the national borders; the ungoverned territory and failed states lack the population of most primary needs, creating the favorable conditions for the emergence of terrorism and extremism. Al-Qaeda's attack in Mombasa, Kenya, in November 2002, which claimed 13 lives and in Alger, April 2007, killing 33 people confirm the vulnerability; the extremist groups and factions are free to create and expand their networks and to develop into terrorist cells in 'troubled' African states, without good governance, adequate security forces or intelligence. In this situation, avoiding the divergences among NATO members about how "global" should be the security generated by NATO, how extensive or preventive should be the measures or actions NATO carries out, US and some European countries did not stay away and responded to the need of urgent international aid, in order to stop the terrorist groups to exploit the critical situation, seeking to extend their activities.

NATO acting in Africa as a mobile peace-building or extraction force supporting an AU or UN mission is the most credible and convenient scenario. Short time action and after, handing over to a UN, Africa Union or regional organization peacekeeping mission. Operation Artemis form Bunia/RD Congo conducted mainly by French forces was a typical and successful one, after accomplishing the mission UE forces handing over the area to UN troops.

A long term commitment is not suitable for NATO forces regarding: the resources spent with its troops (much more than UN troops); the divergent attitude of different local fractions; and eventually the routine and the image in time of the organization.

UN has the experience and the competence to continue and complete the democratization process.

REFERENCES:

Amitav, Acharya and Ryerson, Christie. *Conference Report: Human Security Research: Progress, Limitations and New Directions*, Human Security Journal, Volume 7, Summer 2008.

Amouyel, Alexandra. *What is Human Security?* Human Security Journal - Issue 1 - April 2006.

Aravena, Francisco ROJAS. *Human security: emerging concept of security in the twenty-first century*.

Asmus, Ronald D., *Great Expectations*. NATO Review No.2:28-33 Summer 2003,

<http://www.nato.int/docu/review/2003/issue2/english/analysis.html>

Bennett, Christopher. *Building Effective Partnerships*. NATO Review No.3:2-5 Autumn 2003, <http://www.nato.int/docu/review/2003/issue3/english/art1.html>

Constantin Onișor, Adrian Marius Dobre, Paul Dănuț Duță (eds.), *Partnership for Security..., NATO strategic Concept*, Editura Tehnomedia, Colecția Studii europene nr.4, Sibiu, 2009.

Dahl-Eriksen, Tor. *Human Security: A New Concept which Adds New Dimensions to Human Rights Discussions?* Human Security Journal, Volume 5, Winter 2007.

Edward Rhodes, *Transforming the Alliance: the Bush Administration's vision of NATO. Connections*, The Quarterly Journal. Vol.II, No.3, September 2003.

International Commission on Intervention and State Sovereignty. *The Responsibility to Protect*. Report of the Commission. International Development Research Centre. Canada. 2001, available at www.dfait-maeci.gc.ca/iciss-ciise/pdf/Commission-Report.pdf

Goldstein, Lyle J. *Beyond the Steppe: Projecting Power into the New Central Asia*. Journal of Slavic Military Studies 17:183-213 April-June 2004.

Hampson, Fen Osler. *Madness in the Multitude: Human Security and World Disorder*. Oxford: Oxford University Press. 2001.

Kermani, Parinaz. *The Human Security Paradigm Shift: From an "Expansion of Security" to an "Extension of Human Rights"*. Human Security Journal, April 2006.

Paris, Roland. "Human Security: Paradigm Shift or Hot Air?", *International Security*, Vol. 26, No. 2 (Fall 2001).

Radoslaw Sikorski, *What Future for NATO?*,



Conference held at Helenow/Warsaw, Poland, 22 September 2006.

Murray, Williamson. *National Security Challenges for the 21st Century*. Carlisle, PA, Strategic Studies Institute, U.S. Army War College, 2003. <http://www.carlisle.army.mil/ssi/pdf/00003.pdf>

Serfaty, Simon. *Europe Enlarged, America Detached?* *Current History* 102:99-105 March 2003. "What the West needs, and must seek in and beyond the EU and NATO--the two central institutions that comprise it--is more, not less, integration."

The New Strategic Concept Fact Sheet, this Fact Sheet was released by NATO at the Washington Summit on April 24, 1999, The White House, Office of the Press Secretary.

United Nations Development Programme, 1994, *Human Development Report 1994*, New York, Oxford University Press. Chapter II, 'New Dimensions of Human Security'.

Veronica Ciortea, Adrian Marius Dobre, Paul Dănuț Duță (eds.), *NATO la 60 de ani de la înființare. Perspective românești*, Editura Tehnomedia, Colecția Politică și apărare națională nr.35, Sibiu, 2009.

NOTES:

¹ See, Veronica Ciortea, Adrian Marius Dobre, Paul Dănuț Duță (eds.), *NATO la 60 de ani de la înființare. Perspective românești*, Editura Tehnomedia, Colecția Politică și apărare națională nr.35, Sibiu, 2009.

² The New Strategic Concept Fact Sheet, this Fact Sheet was released by NATO at the Washington Summit on April 24, 1999, The White House, Office of the Press Secretary.

³ *Knowledge of the maritime situation (Maritime domain awareness)*. In this area, where the Alliance needs vision is both a capability and a mission and is manifested, similarly, to the knowledge of the air situation. The product will allow the Alliance to monitor the activity in international waters, which will prove of great utility in resolving crises.

⁴ *Energy security* is one challenge that will confront the Alliance in the XXI century. Of course NATO is not a main actor in this context, but can bring added value in certain sectors that remain to be identified. More than 90% of world trade is conducted on sea, represented mainly by the petroleum and the terminals on-shore reception facilities for hydrocarbons and 65% of Western Europe's gas and oil transit routes transit

annually the communication of the Mediterranean Sea, including pipelines connecting Libya to Italy, Morocco to Spain. In this context, it is clear that maritime security, conducted by allied naval forces, constitutes the precondition for energy security (e.g., Operation *Active Endeavor*).

⁵ Speech of Minister of National Defence of Poland, Radosław Sikorski, *What Future for NATO?*, Conference held at Helenow/Warsaw, Poland, 22 September 2006.

⁶ Bennett, Christopher. *Building Effective Partnerships*. *NATO Review* No.3:2-5 Autumn 2003. <http://www.nato.int/docu/review/2003/issue3/english/art1.html>

⁷ Serfaty, Simon. *Europe Enlarged, America Detached?* *Current History* 102:99-105 March 2003. "What the West needs, and must seek in and beyond the EU and NATO--the two central institutions that comprise it--is more, not less, integration.", <http://proquest.umi.com/pqdweb?did=302556511&sid=7&mt=4&clientId=417&RQT=309&VName=PQD>

⁸ Iulian Sărățeanu, Daniel Pisciă, "New strategic concept – The key of NATO transformation", in Constantin Onișor, Adrian Marius Dobre, Paul Dănuț Duță (eds.), *Partnership for Security...*, *NATO strategic Concept*, Editura Tehnomedia, Colecția Studii europene nr.4, Sibiu, 2009, pp.212-233.

⁹ Mircea-Jan Stoean, Ilaș Silvester, "Transatlantic relations - a competition for security", in Constantin Onișor, Adrian Marius Dobre, Paul Dănuț Duță (eds.), *Partnership for Security...*, *NATO strategic Concept*, Editura Tehnomedia, Colecția Studii europene nr.4, Sibiu, 2009, pp.233-255.

¹⁰ Murray, Williamson. *National Security Challenges for the 21st Century*. Carlisle, PA, Strategic Studies Institute, U.S. Army War College, 2003, <http://www.carlisle.army.mil/ssi/pdf/00003.pdf>

¹¹ Romeo Anghel, Marius Ralea, „NATO revitalisation”, in Constantin Onișor, Adrian Marius Dobre, Paul Dănuț Duță (eds.), *op. cit.*, pp.203-212.

¹² Asmus, Ronald D. , *Great Expectations*. *NATO Review* No.2 :28-33 Summer 2003, <http://www.nato.int/docu/review/2003/issue2/english/analysis.html>

¹³ *NATO Review 2008*, Mr.Xinghui Zhang, „China Youth Daily”, Bruxelles.

¹⁴ North Atlantic Treaty Organization. Office of Information and Press. *Partnership in Action*. Brussels, Belgium, NATO Office of Information and Press, 2003. 23 p, <http://www.nato.int/docu/part-act/part-act-eng.pdf>

¹⁵ Goldstein, Lyle J. *Beyond the Steppe: Projecting Power into the New Central Asia*. *Journal of Slavic Military Studies* 17:183-213 April-June 2004, <http://taylorandfrancis.metapress.com/openurl.asp?genre=article&id=doi:10.1080/13518040490450501>

¹⁶ www.IRChina.Org Academy of International Studies and Department of International Relations, Nankai University. *Foreign Affairs Journal*, No. 75.



¹⁷ Edward Rhodes, Transforming the Alliance: the Bush Administration's vision of NATO. *Connections, The Quarterly Journal*. Vol.II, No.3, September 2003, p.22.

¹⁸ Tor Dahl-Eriksen. *Human Security: A New Concept which Adds New Dimensions to Human Rights Discussions?* *Human Security Journal*, Volume 5, Winter 2007

¹⁹ Roland Paris. "Human Security: Paradigm Shift or Hot Air?", *International Security*, Vol. 26, No. 2 (Fall 2001), pp. 87-102.

²⁰ 1994 Human Development Report.

²¹ *Ibidem*, p.23.

²² *Ibidem*, p.22.

²³ *Ibidem*, p.10.

²⁴ *Ibidem*, p.10.

²⁵ *Ibidem*, p.9.

²⁶ Alexandra Amouyel. *What is Human Security?* *Human Security Journal*, p.16.

²⁷ International Commission on Intervention and State Sovereignty. *The Responsibility to Protect*

²⁸ NATO Secretary General Jaap de Hoop Scheffer' speech delivered at the Kofi Annan International Peacekeeping Training Centre, Ghana; <http://www.nato.int/docu/>; Updated: 26-Nov-2008

Paul DUȚĂ (ppduta@yahoo.com), *PhD*, is a Senior Scientific Researcher within the Romanian Diplomatic Institute.



THE EU INTEGRATION OF THE WESTERN BALKANS STATES AND TURKEY – SECURITY COSTS AND GAINS

*Gheorghe IORDACHE, PhD
Cristina BOGZEANU*

The present paper sets itself to illustrate a clear image of the stage to which the Western Balkans States and Turkey arrived on their way towards the European integration. Having in view the connection between the enlargement policy, as a constitutive element of the European construction, and the necessity to ensure a stable security environment in the community space, we set ourselves, by this approach, to highlight both the security gains that the European Union will achieve when accepting these states in the European club and the security costs that an eventual enlargement delay or halt would imply.

We have chosen to analyze separately the project of the enlargement in the Western Balkans and the one of the enlargement in Turkey, although Croatia, The Former Yugoslav Republic of Macedonia and Turkey are included in the category of candidate countries and the rest of the states from the “Europe’s powder keg” is part of the potential candidate countries category. This approach is founded on the fact that each area is characterized by some specific features, which may determine different security costs and gains for the EU.

Keywords: enlargement, integration, Western Balkans, Turkey, EU, security.

1. A short theoretical approach of the EU enlargement policy

One of the main characteristics of the European construction relies in the variability of its borders. The European Union reached its actual dimension as a consequence of successive stages of enlargement. Officially, enlargement is considered to be one of the main instruments developed by the organization in order to reach its objectives in the area of security, stability and conflict prevention.

Theoretically, any state that respects the principles of democracy, liberty, respect for the fundamental human rights and freedoms and of the rule of law may apply for the status of EU member state. But, in addition, the state must comply with a set of fundamental criteria, known as Copenhagen Criteria (established at the European Council meeting from Copenhagen, in 1993). These criteria require the prospective member state to fulfil three basic conditions:

- a) To have stable institutions to guarantee a mature democratic system, the rule of law, the respect for the human rights and the minorities’ protection;
- b) To have a stable market economy able to cope with the pressure and competition from the internal EU market;
- c) To be able to assume the obligations emerging from the statute of EU member state, especially the ones referring to the embracement of the political, economical and monetary union objectives.

The enlargement process is complicated because the adhesion of a state to the EU is preceded by a range of phases which are meant to prepare that state to assume its role as EU member. On this account, there are signed Association Agreements, Partnerships, the candidate countries receive financial and technical assistance, their progresses are closely monitored and they conduct political dialogues, all with the view to keeping a closer union between the member states of the organization. Overall, all these stages are known under the name of integration often defined as a process running in parallel to the enlargement and even as a necessary stage foregoing the enlargement.

Thus, enlargement appears to be a fundamental political process not only for the organization itself, but also for the Europe’s international relations, in



general. It is included in the very philosophy of the European construction, being a part of the essence of the European project. EU came into being as a result of the efforts to make conflict inconceivable for the European states, a goal which has already been attained. The creation of the European Union has brought an unprecedented period of peace and stability between the European nations. The possibility for a violent conflict to emerge between states is almost void, as the territorial threats that the European countries posed for each other are now history.

Therefore, peace, stability, cooperation were achieved in this space through the gradual integration of these states within the institutional framework of the EU, which constituted itself in an environment of political, economical, institutional dialogue which produced a community of interests and values. Therefore, enlargement is reckoned an efficient mean to establish member states' solidarity and to elude the conflict possibility. From this point of view, EU could be successfully included in the category of the pluralist security communities¹, entities defined as transnational regions, composed of sovereign states, whose peoples nourish well-founded expectations on peaceful changes. Nevertheless, one shall take into account another inner aspect of the enlargement policy – after being implemented, it supposes that the new member state would give up a part of its sovereignty. It's a principle applying for all the member states of the Union and which shouldn't be looked upon as a negative aspect of the adhesion, as a loss for the newcomer state. On the contrary, it determines a mutualisation of responsibilities and offers to the member states the opportunity to assume a superior responsibility, a collective one, which is founded on the voluntary assumption of the responsibility not only for the stability, security and prosperity of the states, but also for the one of the community, in general.

Actually, the enlargement engenders the expansion of the peace and security area, constituted by the EU, de facto. Each and every state which acquires the status of an EU member state is a country which presents the warranty of a democratic government, of the rule of law and interdependency.

The enlargement is not only a projected subsumed to the physical geography, but also a geopolitical project. The European construction

generates an integrative dynamics around its borders, through the stability and prosperity offered to its member states, the European project is meant to magnetize all the states willing to choose this type of international relations and vicinity, relying on solidarity and on the rejection of violent conflicts as solution to their possible disputes. As a consequence, enlargement is one of the EU's catalysts, as far as the continent's security is concerned, as it contributes to the states' stabilization, to the development of their predictable behaviour and to their inclusion in an environment of dialogue and cooperation.

Nonetheless, each enlargement has its own specificity and has a contribution to the institutional change of the EU. Moreover, enlargement is preceded and continued by an ample process of integration, which consists in a range of actions undertaken in order to create a common institutional, political, economical basis for the European states, to create a foundation for cooperation, a common language for all the member states, so that the enlargement shall not bring a state with different fundamental values between the EU member states and make the cooperation difficult.

In other words, the status of EU member state represents a warranty for the stability and predictability of the security environment on the European continent, a warranty for the peace between the states in discussion. The acceptance of the Western Balkans states and Turkey within the European community would determine nothing but positive results, and the ill-founded delay of the moment of their accession could become security costs for the EU. Virtually, each advantage obtained by their accession could turn into a cost paid by the EU, in the eventuality of non-accession.

2. Western Balkans states status

The works of the Thessalonica Council, in 2003, ended with the decision that the Western Balkans states – Albania, Bosnia-Herzegovina, Croatia, The Former Yugoslav Republic of Macedonia, Serbia, Montenegro and Kosovo (as it is defined by the Resolution 1244 of the UN Security Council, adopted in 1999) – shall benefit of European partnerships, with a view of a more extended integration in the EU. Thus, there was opened the European pathway for the states of the region which has been known for century as



the Europe's "powder keg". Since then, the states from the Western Balkans have registered different evolutions on their way to the European integration, *Slovenia* being the only Western Balkans state that achieved the EU membership, in 2004.

The next state in the evolution towards the European membership is *Croatia*, country which is on the threshold of the accession. At the last Intergovernmental meeting from Brussels², there were opened six new chapters of negotiations and another five were closed (freedom of movement for workers, customs union, trans-European networks, statistics, the right of establishment and freedom to provide services), Croatia entering in a decisive stage of the accession process. Although, initially, Croatia aimed at achieving full membership in 2007, in spite of the progresses registered, the European Parliament considered necessary for this state to continue its efforts of cooperation with the International Criminal Tribunal for the Former Yugoslavia (ICTY) and the reform in the judicial area and in the transition to the market economy. Moreover, in 2008, *Slovenia* blocked the opening of new negotiation chapters, because of a dispute on their common border. Currently, Croatia is expected to obtain its full membership in 2010.

Another Balkan state, which clearly evolves towards the European integration, is the *Former Yugoslav Republic of Macedonia (FYROM)*, which achieved the status of a candidate country in 2001. Previously, FYROM signed the Stabilization and Accession Agreement (SAA), and, currently, this state implements the first part of the negotiation chapters – freedom of movement for workers, freedom of establishment and of providing services and capital. Except that, Macedonia has to continue its efforts to meet the political Copenhagen criteria – stable democratic institutions, rule of law, human and minorities' rights. Moreover, international cooperation, relations with the neighbours and full cooperation with ICTY are other aspects monitored by the European Commission, in order to decide the accession. Out of them, the minority issue and the one of the relations between FYROM and its neighbours have an important role. The minority issues are relevant for the capacity of the European perspective to contribute to the stability of the concerned areas. For instance, the violent confrontations between the Slavic majority and the Albanese ethnics, from 2001, were mitigated when FYROM was offered this opportunity. Since

then, this state went through a period of relative stability and registered democratic and economic progresses. On the other hand, the relation with its neighbours is, in this case, an example of the way in which old disputes may delay the road of a state towards the EU. This time, we have in mind the dispute between FYROM and Greece on the name of the first mentioned.

The other Western Balkans states – Albania, Bosnia-Herzegovina, Kosovo, Montenegro and Serbia – are included in the potential candidate countries category, their accession perspective being more remote than the one of the above mentioned states. *Albania* began its accession process in 2003, being the first of the potential candidate countries to start the negotiations under the Stabilization and Accession Agreement. The Agreement was signed in 2006 and was completely ratified, after being signed by Greece, at the beginning of 2009, this event being the last step towards the official application of Albania for the EU membership. Nonetheless, in spite of the progresses registered in the alignment of the legislation and policies to the European standards, the fight against corruption and organized crime remain one of the main issues that this country has to cope with.

In the case of *Bosnia-Herzegovina*, the Stabilization and Association Agreement, the first step towards the EU, was signed in 2005, but this state continues to be highly ethnically divided, unstable from an economical and political point of view, without having developed, yet, its capacity of self-government. The constitutional elements established in the Dayton Peace Agreement and the reforms required by the EU haven't known an optimal implementation because of the disagreements between the political leaders of the two entities composing this federal state – Bosnian-Croatian entity and the Serbian one. In conclusion, Bosnia-Herzegovina continues to have a long way to go towards its acceptance in the European community.

On the other hand, as far as *Kosovo* is concerned, even if it crosses a process of establishing the fundamentals of a democratic state, EU continues to affirm its clear perspective to achieve the full membership of the organization. Moreover, EU continues to be the main security and stability provider in this area, through the missions developed under the European Defence and Security Policy



(ESDP) and its Special Representative.

Montenegro signed the Stabilization and Association Agreement in 2007 and applied for the full membership in December 2008. The EU Council invited the Commission to elaborate an opinion on this application, which is expected to be released in 2010. Nevertheless, Montenegro registered progresses in meeting the political admission criteria, but it still has to improve its administrative capacity. On the other hand, *Serbia*, the hard core of the former Yugoslavia, faced difficulties in making progresses toward the European integration, as it signed the SAA in 2008, and its entry into force is conditioned by the Council's appreciation that Serbia fully cooperates with ICTY. Nonetheless, the new government from Belgrade, established in 2008, has set as a key-objective to take Serbia in the European community. In conclusion, the main instrument that EU has developed in order to properly approach the area of the Western Balkans consists

in the Stabilization and Association Agreement, looked upon as a first step of a long-term approach of the concerned states. SAA is a mean to bring the states from the Western Balkans closer to the European Union, to export the European values, principles and standards in this region³. Still, if the initiation of these agreements emerged from the EU member states' conviction that their security is closely connected to the Western Balkans security and that this area's stability represents a vital interest for them, afterwards, after several stages of enlargement, there was registered, at EU's level, a decrease of the public support for this policy. Although we do not consider that the EU's enlargement process could be stopped, we believe that there is necessary an analysis of the repercussions that such an event would trigger, especially from the point of view of the security and defence aspects. In order to do so, we have chosen to make a SWOT⁴ analysis of the EU's enlargement project towards the Western Balkans.

<p>S (Strengths)</p> <ul style="list-style-type: none"> - The willingness of the Western Balkans countries to cooperate with NATO and EU, on the development of democratic institutions, rule of law and respect for the human and minority's rights; - The clear orientation of authorities towards the European integration. It's about intention, initiative, as the first step towards integration; - By their geographical position, in the immediate proximity of the EU and of the Mediterranean Sea, they are attractive for the EU, too. The stability and security of the whole European construction depends on the climate of stability and peace of this region. 	<p>W (Weaknesses)</p> <ul style="list-style-type: none"> - The negative impact of the local wars and armed conflicts on the national economies; - The continuity of the manifestation of nationalism, which determines the presence of the international forces in Kosovo, Bosnia-Herzegovina and Macedonia; - Authorities' incapacity to manage interethnic conflicts; - Economic deficiencies, amplified by the current financial and economical crisis; - Difficulties in developing mature democratic institutions, in respecting human and minorities' rights (the continuity of a high level of ethnic and religious intolerance); - Corruption and local and international organized crime; - Ethnic and religious politicization.
<p>O (Opportunities)</p> <ul style="list-style-type: none"> - NATO and EU interventions in this area succeeded in mitigating the possibility for a new armed conflict in the region to break out; - The concerned states appear to have assimilated the culture of resolving disputes in the dialogue framework represented by the EU; - The European perspective offered to these states a stimulus for enhancing cooperation between them, as one of the accession conditions refers to maintaining relations of good vicinity. 	<p>T (Threats)</p> <ul style="list-style-type: none"> - The possibility that the terrorist networks expanded in this area; - The probable failure of these states to meet the specific requirements in order to join NATO and EU in full membership; - Enlargement fatigue; - The decrease of the public support in the EU for the continuation of the enlargement policy; - The possibility that this area were turned into the scene of the manifestation of international actors' interests, which assumed the role of great powers.

Figure 1 – SWOT analysis of the EU's enlargement project in the Western Balkans area



The above analysis clearly reflects that the chance of a long-term stabilization for the Western Balkans resides in the accession of the concerned states to the EU. One shall notice that the weak points of this project, the internal vulnerabilities of these countries are, in their large majority, products of their history, consequences of the conflicts and of the poor relations between them, which make them a favourable terrain for the occurrence of the external threats. But the left column, which is dedicated to the positive aspects implied by their integration, is practically founded on the idea of their acceptance in the European community, perspective which engendered not only progresses at internal level, but also reconsiderations of the foreign relations of these states. In brief, the idea of European integration seems to be the only thing connecting the states from the Western Balkans and makes them possible to evolve towards a democratic development and the assimilation of the democratic principles.

3. Turkey's status

Turkey started the collaboration with European Community in 1959, when it submitted the application, in order to become an associate member of European Economic Community. In 1963, Turkey signed an association agreement, which attended the integration of Turkey in The Customs Union (achieved in 1995) and a possible accession of Turkey to the European Community, but only in 2005, the domestic context of Turkey allowed the adhering negotiations to be started. Since then, EU closed only one negotiation chapter, the one referring to science and research, in 2006. Instead, other seven have been opened. It is about business and industry, financial control and statistics, trans-European networks, consumers and health protection, intellectual property and company laws. Beside this, the last European Commission report criticizes the breach of fundamental rights, especially the press freedom and gender equality, which continue to represent major challenges for Ankara.

Of all the candidate countries, Turkey faces the most problems regarding the support of accession, at internal and external level, European debate being focused on accession implications of a large state which, from the geographic point of view, lies only partially on the European continent,

with a large population, mostly Muslim and with a developing economy. Although Turkey is a rather well-developed country and a member of North-Atlantic Alliance, with an important geostrategic position, there are some EU states that continue to remain reserved to it. The most eloquent example is France. In October 2009, after a meeting between the president of France and his Turkish homologue, Sarkozy affirmed his belief that "Europe must stop to be diluted in an indefinite enlargement" and that Turkey, a secular state of 71 millions of people, almost exclusively Muslims, doesn't have the vocation to become a member⁵. However, the same source illustrates the position of Turkish President, Abdullah Gul, who argues that Turkey will continue its efforts to comply with EU rules and that only at the end of this process a correct evaluation of his country could be done. Moreover, France is supported in its position towards Turkey by Germany, which seeks to implement a privileged partnership with this candidate state, which should replace the accession treaty.

However, one month away, the international press announced the conclusion of a tacit agreement regarding Ankara's EU accession, between Turkey and France. By this, the two countries recognize their disagreement on the relationship between Turkey and the EU and point out their common interests – the continuation of the negotiations (Turkey's interest is to achieve a democratic development level comparable to the one of the EU states, and France's interest is to support a democratic, prosperous and powerful Europe) and to develop the political, economical and common strategic interests.⁶

In order to determine the chances of Turkey's accession, the impact that it would have on the Union's security and security costs which would result from the denial on receiving Turkey in the European states club, we will subject Turkey's application to the same type of analysis that we have also conducted for the Western Balkans states. The figure shows clearly that receiving Turkey in the European club would be a contribution to enhancing EU power on the international stage, bringing a series of advantages of strategic, military and economic nature. If the Western Balkan states, where the chance of obtaining a stable and secure situation in the area is closely linked to the prospect of accession, as far as Turkey is concerned is clear



that the membership could become an advantage in the Union's efforts to assert itself as a relevant actor on the international scene. Internal problems that Turkey faces, especially the political ones, could be resolved by its efforts to meet the Copenhagen criteria, which will be completed in the pre-accession period.

However, the specificities of this application consist in the fact that Turkey has features that can be translated as advantageous for the European Union in terms of security, but also as possible sources of instability, for instance, the different cultural specificity or the location in the proximity of Middle East.

<p>S (Strengths)</p> <ul style="list-style-type: none"> - Particularly important geostrategic position between the European continent and the Middle East, between the Black Sea and Mediterranean Sea (areas of strategic importance for the EU); - Military power; - Different cultural background, which could enable the EU to demonstrate compatibility between the two cultures; - The relevance for supplying Europe with energy due to the fact that it has the control on Bosphorus and Dardanelle straits, transit point for Russian and Caspian oil, but also for the gas and oil from Iraq, Iran or the Caspian Sea. 	<p>W (Weaknesses)</p> <ul style="list-style-type: none"> - Proximity to the Middle East, found as a space for expression of terrorist networks; - Cyprus issue; - Issues regarding the respect for the basic human rights; - Different cultural background, considered incompatible with the Union's one; - Large population, which in the conditions of accession, would lead to changing decision-making process in the EU Council and in the European Parliament.
<p>O (Opportunities)</p> <ul style="list-style-type: none"> - NATO member state since 1952; - Participation in ESDP operations; - Member of the Customs Union with the EU from 1995; - It is one of the main economical partners of EU; - It maintained good relations with the Middle East states; - It was involved in stabilizing the Western Balkans and maintained good relations with them; - Role of mediator in the Middle East conflicts (the conflict between Israel and Syria); - Turkey takes part in stabilization missions in Lebanon, Afghanistan and Pakistan, areas in which cultural specificities of the people involved represent an added-value for actions efficiency. 	<p>T (Threats)</p> <ul style="list-style-type: none"> - Unfavourable position of France and Germany to Turkey's EU accession project; - Enlargement fatigue; - Lack of public support from the EU citizens towards Turkey's accession; - Lack of public support of the Turkish citizens towards the accession of their state. - The excessive focus of Ankara on developing relations with the Arab world, under the conditions in which Europeans have become increasingly reluctant to the Turkey's accession project.

Figure 2 – SWOT analysis of EU enlargement project in Turkey

4. Security costs and gains determined by the enlargement

As we have demonstrated in the first part of the study, enlargement is part of the substance of the European project, contributing decisively to the efforts make violent confrontation unconceivable for European states, to determine these countries to resolve their differences peacefully, by providing a formal framework for dialogue. Regarding the Western Balkan states, where crisis and conflict has been constantly part of their reality for centuries, the European perspective contributes to their stabilization and development and to prevent the extension of risks, dangers and threats for the peace, stability, security and prosperity of the whole Europe. In the absence of stable development of

all regions of Europe, the EU could not guarantee to maintain the security environment across the continent.

Although integration of the Western Balkans can be seen as acceptance of unstable countries in the European club and, therefore, integration of possible sources of insecurity within the European construction, the enlargement in this region equals with a warranty for a stable environment on the continent. The Stability Pact for South-Eastern Europe was, practically, the first attempt of the international community to replace the reactive policy of post-crisis intervention in this area with a long term comprehensive approach and based on a policy of conflict prevention. We have already seen, through the SWOT analysis, that the main positive aspects of the evolution of Western Balkan



states are closely linked to EU policy towards these countries, whether we talk about financial investments that have rebuilt the economies severely affected by war or about stimulus given by the Stabilization and Association Agreements to democratic development. In addition, offering the European perspective contributes to their stabilization and the fact that the candidate countries have to strive to meet the Copenhagen criteria, criteria that summarize, in fact, the principles of democracy and market economy, which guide all European countries.

Moreover, after the 9/11 attacks, the international community became aware of the emergence of a new type of security risk, non-state, transnational risk – the international terrorism. The existence of unstable, vulnerable states in the Euro-Atlantic space, whose components do not have the ability to control internal crises and conflicts and which can become areas for the extension areas of terrorist networks and gateways to this area of interest will only increase the security uncertainty of the entities from this space. Even more, there are experts⁷ who fear the development of a hotbed of Islamic extremism in the region, given the effort made by terrorist groups, including al-Qaeda, to increase their influence in the region. Unstable, undeveloped Balkans, without the support of the EU and the international community would represent, practically, an auspicious ground for recruiting new members of terrorist networks, which could easily blend among citizens of European or American cities in order to commit attacks. Therefore, when talking about Western Balkan space security, we should consider not only the security area in the immediate proximity of the European Union, but also the security in the Euro-Atlantic space. Thus, paraphrasing Volker Ruhe⁸, if Europe will stop exporting security, it will have to prepare itself to import insecurity. Regardless of how much will last accession negotiations, the pre-accession period of stabilizing and democratizing the region, we reckon that it is absolutely necessary in order to ensure long-term security of the EU.

In addition, it is also necessary that the Balkan Peninsula is fully integrated into the EU, without leaving any state outside the construction. If European enlargement and integration create stability by eliminating the option of using force to resolve disagreements between states, it is important that this culture of constructive dialogue

to be developed firstly, between the Balkan states. This is because we don't consider the emergence of violent conflict between the Balkan states and EU Member States plausible, although there are disputes regarding the relations between Slovenia and Croatia or between Former Yugoslav Republic of Macedonia and Greece. The Western Balkans states must recognize their common destiny and the necessity to cooperate constantly within the framework of common political institutions.

If the integration of Western Balkans is necessary to ensure the security in the proximity of the EU, the integration of Turkey has other connotations. Turkey is already a stable state, which does not represent a security risk for the EU or for the Euro-Atlantic area. On the contrary, it is a state that, during the recent history of the continent, has acted as a security and stability provider in the region by participating in missions within NATO or EU-led missions, under the ESDP. Turkey, a state with large dimensions, with relatively consolidated democratic institutions, is not likely to turn into an unstable state and possible source of risk for European security if the accession process would stagnate or fail. The costs implied by Turkey's failure to accede are different from those ones involved in the case of the Western Balkans, but they are also substantial.

The first one is generated by its geostrategic position, in the vicinity of a zone of instability. If Turkey receives the membership, EU will have a direct border with an unpredictable region in terms of security and stability - the states of Central Asia, Caucasus and Middle East, which will determine EU to adopt a common position towards these regions and, perhaps, will engender a reconsideration of the European foreign policy. It's a security cost as the EU will need to increase securing Turkey's external border given the fact that it will become very easy for terrorist networks of the Middle East to attack EU using Turkey, but it also may be referred to as an immense security gain. Paradoxically, the physical proximity between EU and the unstable environment from the Middle East, Caucasus and Central Asia could enhance the role assumed by the Union on the international scene and its importance as a relevant actor in the global order. Turkey, a predominantly Muslim state, can be harnessed in the EU fight against terrorism. Thus, it can act as bridge between two distinct spaces, especially



if we consider the good vicinity relations, which Turkey developed with Middle East states, engaging in conflict mediation or stabilization missions. In this case, the mentioned state could have an important contribution to strengthening the Union's soft power. In an article on national missions in Afghanistan, a Turkish expert⁹ says that "Turkey has the capacity to generate soft power in the region. Unlike Westerners, the Turks have a very good image. It should also be taken into account the issue of Islam. Legitimacy and local cooperation with the Turkish troops are supported mainly by symbolic corridors of Islam. Turks are not foreign to Afghans". Moreover, Turkey could allow the EU to act as a link between cultures and to contradict the Huntingtonian theory of conflict between civilizations. When Turkey's foreign minister was asked what Turkey can offer to the Muslim world, through its membership in Europe, he referred to the interaction between these two civilizations, which will replace the "Cold War" between Islam and the West, between Europe and Asia¹⁰.

By refusing to accept Turkey into the European Community, EU will have to assume the risk of being considered an egocentric, introverted construction, intolerant to any other religion than Christianity, an exclusive area of Christianity, which will be taken as a significant cost for EU security. The accession of a state with a Muslim majority in the area of peace and prosperity, represented by the European Community, will send a powerful and important message to the Arab world, namely that it is possible that two different cultures to co-exist, but also will help preventing a situation in which ethnic or religious extremism gained ground in Turkey. Basically, it's a win-win situation, in which EU will gain soft power, but also hard power (Turkey also represents a considerable military power), and Turkey will gain a place under the security, prosperity and stability umbrella, offered by the EU.

Moreover, if Turkey remained outside the European construction, it is possible that Ankara would focus more on the relations with the Islamic world, with countries of the Caucasus and Central Asia, which makes Turkey a more valuable state as part of the EU¹¹. This justifies the statement of the Vice-President of European Commission, Günter Verheugen, "We need Turkey more than it needs us (...) It has a primordial strategic importance

(...). I am talking about the security throughout the whole region. Just imagine what would happen if Turkey should follow a different path than the solid anchoring in the community of Western states. It would be a huge risk for us, which we would rather not assume."¹²

Another debate about the security costs and gains implied by Turkey's accession in the EU refers to EU's energy issue. Turkey is a veritable interface for the energy provision of the European Union, it is a crossing point for the oil and the natural gas coming from Russia, the Caspian Sea and the Middle East towards the community's member states.

Basically, Turkey and the Western Balkan states as well would bring more gains to the Union than Member States and the non-accession would be very expensive for the European Union. Turkey faces the biggest opposition, in what concerns its accession from EU citizens and the reasons are related to its size, to the debate whether Turkey is part of the European continent or not, the relatively low income of its population, the predominance of Muslim population and the alleged incompatibility with the Christianity.

Conclusions

After having analyzed the current stage of progress towards EU accession of the candidate countries and of potential candidate countries, assessed the weaknesses, strengths, opportunities and threats to achieve their expansion projects, we have demonstrated how important it is to overcome the enlargement fatigue for EU's future, in terms of its security, but also for its status on the international scene. Basically, the European Union will not become a remarkable entity on the international arena in the absence of these states. The cultural, civilisational argument issued by Samuel P. Huntington has to be overcome; the European Union should give full swing to the opportunity to network with the Asian states, in order to be looked upon as a global power with a vibrant economy, without risking to turn into a closed civilisational block, oriented to itself with a static economy, a continental and isolated power. EU needs to integrate Balkans in order to ensure its security and Turkey in order to continue its affirmation as a great power on the international scene.



NOTES:

¹ Emanuel Adler and Michael Barnett, „Security Communities”, Cambridge: Cambridge University Press, 1998, p. 30.

² Council of the European Union, Eighth meeting of the Accession Conference at ministerial level with Croatia, Brussels, 2 October 2009, available on-line at http://www.consilium.europa.eu/uedocs/cms_data/docs/pressdata/en/er/110398.pdf

³ CALIC, Marie-Janine (2005), „The Western Balkans on the Road towards European Integration” Internationale Politikanalyse – Frieden und Sicherheit, Friedrich Ebert Stiftung, p. 2.

⁴ SWOT, the acronym from Strengths, Weaknesses, Opportunities and Threats, is a type of analysis which evaluates the feasibility of a project, by identifying strengths, weaknesses (specific to the nature of the projects’ object, having an internal character) and of the opportunities and threats (emerging from the external environment, of the mentioned object, external factors which may help or hinder the putting into practice the project).

⁵ Viorela Precupaş, *Franţa se opune aderării Turciei la UE*, in *Adevărul*, October, 10th, 2009, available on-line at <http://www.adevarul.ro/rss/articol/franta-se-opune-aderarii-turciei-la-ue.html>

⁶ *Turcia și Franța au încheiat un acord tacit privind aderarea Ankarei la UE*, November, 10th, 2009, available on-line at [http://www.realitatea.net/turcia-si-franta-au-incheiat-un-acord-tacit-privind-aderarea-](http://www.realitatea.net/turcia-si-franta-au-incheiat-un-acord-tacit-privind-aderarea-ankarei-la-ue_661492.html)

[ankarei-la-ue_661492.html](http://www.realitatea.net/turcia-si-franta-au-incheiat-un-acord-tacit-privind-aderarea-ankarei-la-ue_661492.html).

⁷ Novi Pazar, *Les expert redoutent une montée de l’islamisme radical dans le Sud de la Serbie*, April, 4th, 2007, available on-line at <http://web.ifrance.com/actu/monde/90311>

⁸ Jane M. O. SHARP, *Spreading the Security Blanket*, in *The Bulletin of the Atomic Scientists*, Vol. No. 54, no. 1, January/February 1998, p. 23.

⁹ Gokhan Bacik in Carmen Gavrilă, *Misiuni Naționale*, in *Foreign Policy România*, no. 13, November/December 2009, p. 79.

¹⁰ Ion M. Ioniță and Ovidiu Nahoi, *Europa va fi o putere globală dacă va deschide ușa Turciei*, in *Adevărul*, July, 6th, 2009, available on-line at <http://www.adevarul.ro/articole/2009/ahmet-davutoglu-europa-va-fi-o-putere-globala-daca-va-deschide-usa-turciei.html>.

¹¹ Mihai V. Zodian and Ioana Ionescu describe the temptation of neo-ottomanism in Turkey, as a trend which could keep Turkey away from the European project and bring it closer to the states of the Middle East, in the article *Europa de Sud-Est* published in **Lumea în 2009. Enciclopedie politică și militară. Studii strategice și de securitate.**, coordinated by Teodor FRUNZETI, PhD, Vladimir ZODIAN, PhD, Editura Centrului Tehnic-Editorial al Armatei, Bucharest, 2009, pp. 487-488.

¹² *UE are mai multă nevoie de Turcia, decât are Turcia nevoie de UE, consideră Verheugen*, 18th of October 2009, article available on-line at http://www.realitatea.net/ue-are-mai-multa-nevoie-de-turcia-decat-are-turcia-de-ue--considera-verheugen_643417.html

Lieutenant Colonel Gheorghe IORDACHE, PhD (iordache65@yahoo.com), is the head of the Security Office within the National Defence University “Carol I”.

Cristina BOGZEANU (cristina_bogzeanu@yahoo.com) is a scientific research assistant at the Center for Defence and Security Strategic Studies within the National Defence University “Carol I”, and earned a University degree in international relations and European studies.



ENERGY SECURITY – A MAJOR STRATEGIC STAKE

Doina MUREȘAN, PhD

The ability of a state to use its resources so that it could influence the international relations in its own benefit illustrates the actuality of the fact that any state will make use of all its resources at hand, including energy, in order to impose its will and to control the actions of other actors with a view to fulfilling its own goals.

Keywords: security, energy, resources.

***“The humankind is at a crossroad of its historical development: to follow its cancerous way or to take the path of the organic development”
(Siebker Manfred, Kaya Yoichi¹)***

During the last century, the industrialization, the technological progress and the rapid development of the infrastructure have permitted the accumulation of an immense richness, have raised the human living standard and animated the humankind. But the energy resources should be fully accessed in order to maintain prosperity, carry on progress and extend development on the whole planet.

The global economy depends so much on the energy resources that a quick raise of consumption, of the oil price or an unexpected decrease of the oil production could lead to surprising effects. During the last years, given that, at the beginning of the new millennium, the world remains highly conflictive, the oil production has been affected by three political circumstances – the Arabian embargo in 1974, the Iranian Revolution in 1979 and the Golf War in 1991.

We may include here the crisis between Russia and Ukraine that left EU without gas in the middle of the winter. The energy security is somehow related to the foreign policy, to the economy, to the protection of the environment, to the military field and, of course, to the social security.

And the energy crisis have affected traditionally powerful states that do not own enough oil, gas and charcoal resources for the present and for the future and have transformed the states that have

them into regions of geopolitical interest or into credible actors on the global chess-table.

The rivalry of the great consumers for access to resources is very intense. Japan and China, for instance, are constantly outbidding for access to the Siberian oilfields. While the Chinese diplomats and Japanese energy companies have made tempting proposals to the Russians for creating an oil pipeline of 3600 km from Siberia to Japanese Sea, China, which is experimenting a vertiginous economic raise, in completion with USA and Japan for access to the Siberian oil, pleads for abandoning the Japanese proposal and building a shorter pipeline (of about 1300 km) that could link the Siberian fields with the Chinese oilfield in Dakin. We must notice the rapid success China had in Africa.

Serge Michel² thinks that what is important is not the African oil that China is buying at the market price, namely 20% of the imports, but the oil this state produces in Africa. China has massively invested in Sudan by building oil wells, a refinery and a huge oil pipeline towards Sudan Port while other international companies left the country, for various reasons, in the 80s. We remember that between 2000 and 2007 the commercial exchanges between China and Africa increased from 10 billion dollars to 70 billion dollars, China becoming thus the second Africa’s great partner, after USA.

We also have to notice that Russia holds 26.2 % of the world’s known gas resources and that, in 2005, it contributed to the global gas production by 21.6% and to the global oil production by 12.1%³. At this rate, by 2035, the global economy will use twice energy than at present and the oil demand will reach about 140 million barrels per day. The gas consumption will also rise by more than 120% and, in order to deal with this huge growth, the oil companies and the oil producing states will be forced to discover and release 140 million oil barrels per day. Russia brings a few percents to the global production of liquefied gas.



But we should not forget that the first Sakhalin plant has been inaugurated this year and the two production lines of the plant can produce today 9.6 million of liquefied gas tones per year. The Sakhalin plant will start working at full capacity in 2011. A factory is planned to be built on the Baltic Sea shore in Primorsk and in Yamal Peninsula in the Kara Sea, named, rightfully, Russia's "oil deposit" (about 220 layers with tenths of trillions cube meters have been discovered there). Major foreign companies, that are acting on the Russian market or are partners in many other projects, have already expressed their will to participate to the construction of the liquefied gas in Yamal.

"The world needs more and more liquefied gas. This can be explained by the fact that it is more comfortable to be transported and deposited. That's why Russia, the biggest gas producer and exporter, will follow this priority direction", says Alexei Belogoriev, expert at the Institute for monopolies on the natural resources.

"This interest is particular obvious from the fact that the liquefied gas market is mainly developed in the hydrocarbons markets. At present, the liquefied gas has already reached 28% of the whole global gas trade, while, not a long time ago, it ranged between 15-20%. The second reason is due to the fact that Russia aims at diversifying the exports so that not to depend on a single consumer, in Europe mainly, where gas is delivered through pipelines. And the liquefied gas exports, which are more operative and mobile, are offering such a diversity potential." According to the energy strategy, by 2030, the liquefied gas in the Russian exports will have reached 14-15%, which means about half of the whole present Russian gas export.

The second global consumer after the United States – EU -, holding 20% of the global oil consumption, imports most of these resources (80%) and the four major economies consume more than half of the hydrocarbons (Germany, the United Kingdom, France and Italy). It is only the United Kingdom, Denmark, Italy and Romania that possess their own resources, but they are constantly diminishing, as well as the oil in the North Sea. As a percentage, 25% of the EU oil is imported from Russia, 24% from the Middle East, 21% from Africa and 22% from Norway, with a visible raise of the role played by Russia in comparison with to the Middle East. Putin revealed his opinions regarding the energy resources and the future of Russia in

1990, before being elected, in a dissertation paper entitled "The mineral prime materials in the development strategy of the Russian economy", where he pointed out the importance of the natural resources held by Russia, the guarantee of the Russian economic security, and its influence as an actor on the international scene. From a strategic point of view, given the management and the legal distribution of the energy natural resources, Putin imposed nine principles⁴: legislative changes to ensure the state control; establishing an efficient system of state management; the legal premises for stimulating creativity and investments; the optimization of volumes and the diversification of the investment sources; the development of the export-import procedures; the definition of the rights and obligations of the federal and local state bodies, by harmonized normative acts; clear administrative and penal sanctions for disobeying the regulations; maintaining the energy infrastructure under the state property and control; the support of the state for scientific research. Following the redefinition of the Russian global security strategy, by emphasizing the energy dimension, we can notice a decrease in dislocation and preservation of military power to support the geopolitical positions and a perseverance in using the economic resources to support the regional policies. The enlargement towards East of the EU increases the interdependence and brings closer the two of them: Russia shares 2200 km of common border with the EU, is its largest neighbor and they signed a Partnership and Cooperation Agreement in 1997, supported and motivated by economic and commercial contractual relations. Given that, the partnership with the EU can express itself by common efforts regarding the establishment of an efficient system of collective security in Europe, based on the equality of rights and without any dividing line, especially in the indirect way of putting into practice the Security Charter for Europe.

The European Union is therefore confronted with some problematic aspects: the raise of the energy consumption, together with the decrease of its own production, which inevitably leads to the increase of the energy imports and, in order to deal with these challenges, immediate actions are required, both internal and external. Internally, it is necessary to find new energy technologies that can play a key role in a sustainable future for the EU.



At the same time, externally, the energy corridors between the EU and the neighbouring countries are of a major importance for the energy security. We are talking not only about the states that supply, but also about those involved in the energy transit.

The countries from the north, east and south will play an increasing role in the future of the European Union as energy supplier. It is therefore necessary to integrate the energy markets of the neighbouring states with the EU market, with a focus on the compatible relations, on a network of compatible markets, but also on compatible environmental policies. Given the proven dependency of imports, the energy corridors are the key for providing the energy security of the European Union.

Few have understood, in Europe, the importance of the geopolitical axe Caspian Sea - Black Sea - Mediterranean Sea and the future energy corridor that is being discussed nowadays by the main governments from Washington to Beijing and from Moscow to Tehran. It is now obvious that Russia needs Turkey and, at the same time, Turkey needs Russia, Europe needs Russia and Russia needs Europe, Russia needs the USA as well as the latter need Russia, and the series of these energy interdependencies that have been formed may go on.⁵ European Union too, as a strategic actor on the economic global scene, can no longer postpone the moment it will have to carry on a coherent energy policy, taking into consideration that the very fate of the European Union is at stake when it comes to energy security.

The American vice-president Joe Biden stated during his visit to Romania, in October 2009, that *“A lesson that we need in order to cooperate is securing the energy for the future. We need an energy security that includes the diversification of sources and of the transit corridors, smart investments that can cope with the climatic changes. In this region, history, geography and traditions have given the countries the opportunity to play a leading role”*. We can say that the Nabucco project is a chess piece on a table that goes beyond the territory of our country.

The European Commission proposed in the acts representing “The new Energy Policy of the European Union” several major objectives by 2020: diminishing the gas emissions by 20% comparing to the 1990 level; raise of the recyclable energy proportion in the whole energy mix from less than 7% in 2006 to 20% of the total energy; increasing

the proportion of bio combustibles to at least 10% of the total used combustibles; the diminishment of the global consumption of primary energy by 20%.

According to the objectives mentioned in the *White Charta of the European Union*⁶, it is estimated that, in 2010, at European level, the electric energy that comes from recyclable energy sources (RES) will be: aeolian energy: 80 TWh/year; high power hydro: 300 TWh/year; low-power hydro: 55 TWh/year; photovoltaic: 3 TWh/year; biomass- 230 TWh/year; geothermal: 7 TWh/year.

Under these circumstances, in order to reach a proper energy standard, it would take much more energy than our present system or other easy to build system can produce. It is hard to say how far this oil course will go, but energy security is likely to become the newest pretext for generating geopolitical conflicts. The relation between holding, demanding, supplying and using energy resources, the geographic position and the access to resources, on one hand and the security problems, on the other hand, is obvious. The control over energy resources –oil, natural and liquefied gas, fossil combustibles - has become a priority objective not only for the major actors of the global scene (USA, EU, the Russian Federation), but also for the new ascending powers (China and India). The regional or international organizations also play a significant part on the energy scenery.

The energy strategy sets as Romania’s main goal for 2007-2020 “the guarantee of the necessary energy both at present and in medium and long term, at a price as low as possible, proper for a modern market economy and for a civilized standard of life, respecting the alimentation quality and safety and the durable development”. The strategic objectives include energy security, lasting development and competition. In order to fulfill these objectives important steps have been made by the interconnections to the oil pipelines (Romania - Hungary, Romania - Bulgaria, Romania - Serbia). In the package of legislative acts of the European Union “Climatic changes/ recyclable energy”, by 2010 Romania should own 33% green energy, by 2015 35% and by 2020 as much as 38%. The main strategic guidelines in the Romanian energy policy, in accordance with the objectives and policies established at the level of the European Union are: *for energetic security*: maintaining the national sovereignty on the primary



resources of energy and respecting the national options in energy; an increasing safety for the energy offer and the preservation of an acceptable degree of dependence on imports by diversifying the import sources, our own energy resources, the national and regional routes and networks of transport; protection of critical infrastructure. For *the durable development*: increasing the energy efficiency throughout the whole channel resources – production – transport – distribution – final consumption by reducing the final consumption of primary energy in relation to the value of products and services; the growth of proportion of the recyclable resources-based energy in the total consumption and in the electricity production; efficient and rational use of primary unrecyclable resources and the progressive change of their ratio; promoting the production of electric and thermo energy in cogeneration factories, mostly in the most efficient ones. For the valorization of secondary energy resources: supporting the research activities – development-innovation in the energy field, with a focus on the environment and with the compliance to the obligations assumed regarding the diminishment of gas emission and other pollutants.

In order to decrease the impact of the energy security on the climatic changes we envisage the reduction of gas emissions by about 10% in 2013 comparing to the reference year 1989. Romania will be actively involved in the establishment of the objectives for the second implementing period, post 2012, of the Kyoto Protocol at the United Nations' convention regarding the climatic changes and the negotiation of certain international agreements with responsibilities in this field.

We will review the events concerning the energy issue during the last year in order to have a point of view about the intensity of their study and examination. Thus, the international EU-Ukraine investment *Conference for the rehabilitation of the transit gas networks of Ukraine* held in Brussels (March 23, 2009) that was intended to identify the necessary measures for reforming the Ukraine energy field and to attract the necessary investments for rehabilitating the transit networks; the *Reunion of the Permanent EU-Russia Partnership in the energy field* (March 30, 2009); *Sofia Summit* (April 24-25, 2009) whose main objective was to guarantee the European energy security and to encourage the dialogue among consuming, producing and

transit countries; the International Conference “*Safe and stable transit of energy resources and its role in ensuring the durable development and the international cooperation*” (Ashgabat, April, 23-24, 2009) that represented the Turkmen initiative to create a legal international framework for guaranteeing the security of the transit for the energy transporters; *The Prague Summit of the Southern Corridor* (May, 07, 2009) that aimed at discussing the tangible ways to continue the development of the southern corridor for energy and transport, especially the supply of the European Union with gas through this corridor and the beginning of a consolidation process of the cooperation relations between EU and the states bordering this corridor; *EU – Russia Summit* (May, 29, Khabarovsk), where the main issues were security, commerce, energy; *the Ceremony of Signing the Nabucco Agreement* (July, 13, 2009, Ankara), where a Common Declaration of the partner states was signed, stipulating political engagement to respect the guidelines of the Agreement and engaging all necessary efforts to accelerate the ratification procedures and to negotiate and create the Project Support Agreement.

Energy security became an issue intensively debated, which shows that the use of energy resources, mainly oil and gas as an instrument of force may have the same devastating effects as the use of military force⁷. In this context, the American senator Richard Lugar insisted during the Riga summit that “there is no difference between the correction inflicted upon a member state by cutting off their energy resources supply and the one caused by a military blockade or by a force demonstration at its borders”. Under these circumstances, energy security no longer constitutes a regular objective of economic policy, but has become a constant preoccupation for the international community. Energy security is at the crossroad of all security dimensions as its achievement depends on reaching a certain level of political and military consensus has a direct impact on the economy, society and the environment, and, not the least, aims at protecting every single human being.

The Walter S. Jones's definition of the concept of power – the ability of an international actor to use its tangible and intangible resources in such a way that it influences the results of the international relations to its own benefit⁸ - illustrates the actuality of the fact that any state will make use of all the



resources at hand, including energy, in order to impose its will and to control the actions of other actors with a view to fulfilling its own goals. In a nutshell, power means resources, strategies and results.

SELECTIVE REFERENCES:

DUNN R.J., *The Food Crises*, American Thinker, 29.04.2008.

Eduard LUCAS, **The New Cold War**, Bloomsbury Publishing, 2008.

EPOSITA John, *Foreign Policy*, April/May 2008.

Michel SERGE, Când China întâlnește Africa, *Foreign Policy*, June-July 2008.

MUREȘAN, Liviu, *Securitatea energetică în acțiune*, Adevărul, October, 4th, 2009.

NIES Susanne, **Gas and Oil towards Europe**, RCR Print, IFRI, Paris, 2008.

Walter S. Jones, **The Logics of International Relations**, Seventh Edition, Harper Collins Publisher.

NOTES:

¹ SIEBER Manfred, KAYA Yoichi, Comité executive du Club de Roma: Rapport de Tokyo, Editions du Seul, Paris, 1974.

² Michel SERGE, Când China întâlnește Africa, *Foreign Policy*, June-July 2008, p.70.

³ xxx, Statistical Review of World Energy, British Petroleum, 2006.

⁴ KOTOV Vladimir, *Russia's Mineral Resources-Reconfiguration of Institutional Framework*, lecture in Philippines, at a conference dealing with the Natural Assets.

⁵ MUREȘAN, Liviu, *Securitatea energetică în acțiune*, Adevărul, October, 4th, 2009

⁶ Commission of the European Communities, Communication from the Commission Energy for the Future: Renewable Sources Of Energy - White Paper for a Community Strategy and Action Plan .

⁷ NATO School, Germany, 19 -20 .07.2007, workshop Energy Security.

⁸ Walter S. JONES, *The Logic of International Relations*, Seventh Edition, Harper Collins Publishers, 1991, p. 241.

Lieutenant-colonel Doina MUREȘAN, PhD (dmuresan_cnap@yahoo.com), is the Deputy Director of the National Defence College and Associate Professor within the National Defence University „Carol I” Bucharest, Romania.



POWER RELATIONS BETWEEN REALISM AND NEOREALISM IN HANS MORGENTHAU'S AND KENNETH WALTZ'S VISIONS

Niculae TABARCIA

The international relations, as a field of the academic research, consists of two fundamental trends—realist and liberal—that endeavor to theorize the nature of the international system of states and its modus operandi. Although the intellectual roots of the realism are often identified in Thucydides' stories on the Peloponnesian Wars, the first classic actors of realism (Niccolo Machiavelli, Thomas Hobbes) came about a few centuries later and the first realist extensive theories on the international relations emerged in the 21st century. This essay intends to compare the approach on the concept of power used by Hans Morgenthau and Kenneth Waltz in their works which are considered as being representative – Politics among nations, The man, the state and the war, respectively and The theory of the international politics. In Politics among nations, Morgenthau made an exposé on the vision resting on the relations among states in the international stage which has dominated the study on the international politics for almost two generations, while Kenneth Waltz, through The theory of the international politics, divided the realist group into two parts – classic realist and neorealist. Nevertheless, a partition of the approach used for the power concept following a simple way which is that of trends, realist and neorealist might prove ineffective given that it could try to harmonize two groups of thinkers who manifested considerable variations as far as the levels of approach are concerned – from the adopted perspective on the level of the system or of the state-actor to the actual elements of the foreign policy. Thus, Hans Morgenthau (classic realism) and Kenneth Waltz (neo-realism) have been selected as representatives of the two thinking trends due to the influence each exerted within the trend they belong to.

Keywords: realism, neorealism.

Realism and neorealism. Power's nature and goal

The realist paradigms are rather empiric than normative and their subject matter is the international system that is built upon the relations among states and not the way it should be. The realist schools believe that the world is the result of the human nature itself and at the same time is "a world of contrary interests and conflicts".¹

The supporters of realism underscore the persistence and inevitability of the conflict that can take the shape of rivalry or even war in the international relations, as a result of the regularly divergent interests of the major actors of the system—the states. The national interests represent the engine that triggers the behaviour of states that are rational, self-centred actors driven by the mechanisms of the state reasoning. The realism pays a special attention to the great powers that possess many advantages/resources used along the race for interest's accomplishment². For this reason, the realist theoreticians consider the distribution of power and capabilities as focal core since it influences the developments on the international political stage.

The abovementioned aspects are widespread among realists even if they are Hans Morgenthau's followers or Kenneth Waltz's. There are a few fundamental differences between the thinking trends represented by the two authors.

Firstly, the classic realists consider that the sources of conflict and wars subsist in the human nature, while the neorealist ones consider that it stems from the chaotic nature of the international system.

Secondly, from the ontological point of view, for the followers of the political realism presented by Hans Morgenthau, the state is beyond the system



unlike the neorealist vision and thus it provides more room for action and manifestation of power within the sphere of the international politics³.

Thirdly, the realists confine themselves to underscoring the differences between power either they are *status quo* like or *revisionist*, while the neorealists strive to introduce in the equation all states acting as unit actors⁴.

The fourth difference resides in the methodological nature. While the neorealists are the supporters of an unbiased scientific approach, the classic realism explores the influence of the bias human nature on the foreign policy of the states and implicitly on the power relations among the states within the international system⁵.

Morgenthau and Waltz present the international system as a hostile and competitive environment wherein the power is the engine of the relations among the actors and subsequently this concept is the basis of the analysis on the international politics. The attitude of the realists towards power is complex and seemingly paradoxical. Thus, while the destructive capability of power requires control upon it, the power should be used given that it is a real and natural phenomenon which existence cannot be overlooked⁶.

In Morgenthau's opinion, the power may be used differently depending on the political and cultural environment and it comprises "anything that establishes and maintains control of the man over the man". Thus, power is broadened as a component element of any social relations that serve on the purpose of controlling" from physical violence to more subtle psychological ties that are used by a human mind to control other human mind⁷. It can be noticed that in Morgenthau's approach the power is not confined to its material aspect— like a material force, more precisely like a military force, but it consists of any means used to control other entities either by disciplined use of force or by uncontrolled and cruel force⁸.

The intricacy of the definition on power used by Morgenthau also derives from the fact that he considers power as both a goal and a mean. The international politics as well as other types of politics is a struggle for power and irrespective of its goals, its primary is to obtain, keep or increase power. At the same time, given that it represents a goal in itself, the power is one of the main sources of conflict at all three tiers – individual, inside the state and within the international system.

The political power is a psychological relation among those ones who exert it and among those ones being exerted it upon and the effects of power have three sources: benefits' anticipation, fear in case of disadvantages and deference/ dedication to people and institutions⁹. Moreover, Morgenthau makes four differences between power and influence, between power and force, between utilizable power and non-utilizable power and between the legitimate power and illegitimate power¹⁰.

As to the level of analysis, Morgenthau starts with the individual level (first page) based on the universal and permanent character of human nature, struggle for power at international level being, mostly, the result of the desire of the political man to dominate. However, the thinker does not stop at this level, emphasizing that the state is a collective reflection on this human will to dominate and the main way in which the individual's desire for power is represented on the international political stage. Morgenthau's analysis also covers the international system. Although he does not consider anarchy a cause of the struggle for power, this condition of the international relations system is not ignored but, rather than otherwise is seen as a permissive force. In the absence of a dominant actor, of worldwide governance and of a well established hierarchy, the state is free to internationally show the craving for power.¹¹ In Morgenthau's view, "the essence of the international politics is similar to that of the inner policy. Both mean struggle for power, changed only by the various circumstances at internal and international level"¹². Thus, there is no essential difference, but only one in terms of degree, between the inner and international politics.¹³

Although Hans Morgenthau combines all the three levels of analysis, he is criticized by Waltz in the **Man, the state and the power** for being a first image thinker (the stress on the human nature makes the theory hard to be proved).¹⁴ The most serious accusation of Waltz is that Morgenthau has appealed to reductionism trying to explain the entire international system through the sum of its components.¹⁵

The power definition given by Kenneth Waltz is visibly more limited than that one of Morgenthau regarding the defining process based on objective and scientific rigorous elements. In Waltz's view, "an agent is powerful if he affects others more



than they affects him".¹⁶ His definition is focused on an actor's capabilities and their distribution. The power of an agent/actor on the international stage can be estimated by measuring the size of the population and territory, the human resources, economic capability, military power, political stability and the level of competence of the structure of the respective state/agent. Even if he gives a great importance to the material factor, his theory also offers non-material dimensions like political stability and competence. The reason for what Waltz emphasizes the material and countable elements are about his engagement in the "scientific" realism. As a consequence, the Waltz's vision on power is limited to concrete variables.

In Waltz's vision, the power is a way not a purpose. His argument is: "if states were willing to maximize their power they would come beside the more powerful part and we would not witness how balances are made but how a worldwide hegemony is created. [...] The states' main concern is not to maximize their power but to maintain their positions within the system".¹⁷

Conceptually speaking, like Hans Morgenthau, Kenneth Waltz also considers that power is not an absolute notion because people, and also states, are permanently reported to their neighbors.¹⁸

Defining power in terms of capabilities distribution and as a way of reaching objectives leads to a certain "hierarchy", logically inferred, of states in the international system. Even if states are dealing with similar tasks, their capacity of accomplishing these tasks is different and depends on their capabilities in comparison to other states. Thus, Waltz considers the number of great powers (capabilities net superior to those of most states) very important in analyzing international relations, coming to a distinction among three types of systems – single-polar, bipolar, and multi-polar¹⁹, understanding that the bipolar system has been proved as the most stable of all three.

However, by having capabilities, it does not mean that one has the guarantee of the permanent success at the international level, since the level of capabilities of an actor is relative in the case of the rivals' capabilities and it might influence the symmetry of power at the level of the system.²⁰

To avoid Morgenthau theory's deficiencies, Waltz tried to find the reason of the struggle for power at the level of the system. Consequently, the anarchic nature of the system leads to the

self-assistance policy and to the policy of power. Permanently threatened from the point of view of their status and security, states are rather engaged in a fight for survival in the anarchic international system without a global government intended to offer them protection and engaged in a sharp competition for resources. In order to survive, state will try to increase its power (defined as capabilities) which does not necessarily mean its maximization. Power is not a purpose but a way to reach and maximize security.²¹

Power relations, impact on the international system

International politics is, like other types of politics, a struggle for power in Hans Morgenthau's view. Based on the interpretation of the historical facts, he emphasizes that the foreign policy of the states in the international anarchic system incline to follow one of the three patterns of behaviour: maintaining the balance of power, the prestige policy or the imperialism, and identification of circumstances determining the policy that states will follow and the goals of such types of policies.²²

Thus, according to the status-quo politics the balance of power existing in a certain historical moment should be maintained. The paramount moments for such type of politics are usually represented by the end of wars when the power distribution stemming from the conflict is encoded within a peace agreement meant to guarantee the stability of the new distribution of power through legal stipulations. Under these circumstances, states adopting the balance of power policy become defenders of the peace agreements.²³ However, the balance of power policy is not necessarily opposed to any type of change but only to that destined to produce the overthrow of the power relations among two or more actors.²⁴

On the other hand, imperialism is meant to overthrow the balance of power. Hans Morgenthau considers three factors stimulating imperialism: victory in wars (the state which anticipates victory will try to initiate an imperialist policy), defeat in war (the subordination relation resulted from the defeat may determine the defeated part to will to overthrow the balance of power to its advantage) and weakness (weak states or absent power areas are attractive for a powerful state).²⁵ The aim of



imperialism might be that of creating a worldwide empire, a continental one and getting the local predominance applying methods like military, economic or cultural imperialism in measures varying function of the concrete nature of the situation.²⁶

Unlike the retention of power (status-quo policy) or its growth/increase (imperialism), the prestige is rarely a goal by itself, and constitutes the tool through which the other two types of politics achieve their objectives.

The goal of the prestige politics is to make an impact on other players of the international system through power owned (or displayed), and in order to achieve this goal it makes use of the diplomatic protocol and reveal military force.²⁷

The balance of power serves, according to Morgenthau's vision, as a device/mechanism intended for the organization of the international system, within its framework analyzing the difficulties related to power measurement and the stability level for various configurations of power.²⁸ At the same time, the quest for a balance of power is a fundamental and steady characteristic of the system of states.²⁹

Kenneth Waltz does not distinguish between the types of politics, as Morgenthau does, because the latter approaches the power relations from the state level to the system level, while the exponent of the neorealism has an approach from the system level to the state level.

Within the international system, the states are making great efforts in order to increase their power or to recover it through alliances if they do not keep the pace, but nevertheless security achievement is the main goal of the states within the anarchic system.³⁰ This thing is happening because a powerful trend towards balance exists at the level of the system. Once a certain power balance within the system is achieved, this does not have a durable character, under the circumstances of the anarchic and dynamic international environment. Once the balance of power is disturbed, this will be revived, because the states engage into a counterbalance behavior, no matter if the balance of power inside the system is a goal of their actions or not. Therefore, Waltz says that the international system is challenging, and the states will display characteristics similar to those ones of their economic competitors – will imitate each other and will finish by adapting themselves to the system³¹.

At the level of the international system, the actions of states will generate balances of power. This is a fact independent from the conscious wish or action of the states. The anarchic structure influences the behaviour of the state in this direction. The policy of the balance of power prevails when two prerequisites are fulfilled: the topic is anarchic and is populated by elements that wish to survive³².

The behaviour of the state is framed within two types: counterbalance (balancing) and alignment (bandwagoning), which are opposite³³. The security imperative, in the opinion of the author, makes rationalism be the first type of behaviour – counterbalance the superior power of a state or an alliance of states. The alignment to the powerful state is not considered a solution, due to the fact that it can turn against the current partners later, and the state will remain exposed in front of the threat. The counterbalance of a potential aggressor will not take into account only the reasons but also its capabilities. This may be achieved through internal efforts (increasing the self capability) or external efforts (building alliances)³⁴.

Conclusions

The two authors contemplate in a different manner not only the nature of power (material/non-material) but also the source (the individual/the system) and the goal of the confrontation for power (domination/survival). It could be said that, while from Morgenthau's point of view, the power is rather a purpose by itself and the source of conflicts at an international level, while for Waltz power is the mean used by states in order to ensure their survival.

This different approach of the concept of power, corroborated with a diverse use of analysis levels (Morgenthau focuses on unit - state), while for Waltz the structure of the system is the most important) generates a different perspective on cause and attractiveness of the power, both authors considering the concept of "balance of power"³⁵ a necessity. Both approaches make the distinction between the dominant and the dominated state, the powerful and the weak state, meaning great powers and smaller ones, according to the distribution of capabilities.

If Hans Morgenthau's theory allows the identification of various patterns of behaviour



manifested by the state actors, Kenneth Waltz emphasizes mechanisms which should balance the power equation at the level of the system, obtained following the struggle for power/survival.

Though they manifest major methodological and key-concepts approaching differences, the two theories are strongly complementary. As Morgenthau's realistic theory is not completely concentrated on the unit-actor, Waltz's theory is not a purely systematic one, together allowing a more complex approach of the power relation system and processes within it.

Beyond these theories, in the international relations practice, the previous situations require a flexible approach, the only one that could make explanation successful.

Being theories, they cannot end the immense diversity of reality. An example could be the United Nations, which, in some situations, succeeded to act as an element moderating the natural tendency of the states towards a more visible position of power, triggering the conclusion that the institutions themselves represent an ingredient of international relations that cannot be neglected.

Thus, an opportunity in this field might be a successful reform within the UN Security Council, to remove the possibility of blocking its functioning because of confronting stands between veto-wielding countries. If such dilemma is worked out, states may be offered a different option than choosing between counterbalancing and alignment, and such alternative would be generated by the need of acting on consensus basis for mutual values and interests. Yet, establishing mechanisms for such a pattern could represent the subject of a liberal approach which allots special attention for institutions within the equation of international politics.

From the prospect of international relations theory, the UNO was intended to stand for the materialization of liberal-institutional concept. Yet, the structure and functioning of the Security Council indicate a struggle for maintaining power by the permanent members (USA, the Russian Federation, the United Kingdom, France and China). Though the veto power does not always offer them the capability of following their own interests, it bans using UN against them. The logic that stands at the core of the Security Council is avoiding antagonizing these world's powers and diminishing the risk of inflicting a major conflict

through the involvement of other aligned actors or dividing the UN on criteria of influence or interest circles³⁶.

Thus, as long as the world's powers hold the veto right, one may assert that they possess peaceful means for defending their own interests. If the reform of the Security Council led to removing this right, the five permanent members would be strained to find different means of defending and advancing their national interests, even aggressive ones.

The concept of revisionist state, as state that operates in order to modify the "status quo", should not be forgotten. The reform of Security Council is not required only by pragmatic reasons, such as the need to eliminate the blockages that are allowed by the current functioning system of this structure. States as Germany (one of the major contributors to the UN budget and a great European power) or Brazil (one of the biggest armed forces within the organization) consider themselves entitled to occupy a permanent seat within the Council and to promote their national interests through the veto right. Their wish is blocked both by the more or less spoken out opposition of the current permanent members and the resistance of other states - Italy opposing Germany, Argentina and Mexico opposing Brazil. However, these divergent conflict generating stances should justify, only in extreme situation, the launching of an armed conflict. The concept of avoiding the armed conflict through a system of alliances and alignments represents the base of the UN setting-up.

On the other hand, the perspective that "the five" or other UN member states should remain on divergent stances, able to cause a critical situation that might generate an armed conflict, is significantly low within a global and highly interdependent world in terms of economics and new common threats against the security (mainly, asymmetric threats, global issues - poverty, pandemics, ecology). Exceptions such as the US intervention in Iraq are possible, but they only represent the prerogative of the great military powers, supported by a strong economy with a large sphere of influence.

It could be assessed that, given the current political and economic order, any change in power relations area is also possible through peaceful means. Although this aspect is neither favored by supra- or inter-governmental structures, is



might become possible due to common national interests, high level of interdependence among great economic and military powers, as well as to the high costs of a potential conflict and the incertitude of amortizing these costs.

REFERENCES:

- GRIFFITHS, Martin, *Relații internaționale. Școli, curente, gânditori*, București, Ed. Ziua, 2003.
- HOBSON, John M., *The State and International Relations*. London: Cambridge University Press, 2000
- JACKSON, Robert H., Georg SØRENSEN, *Introduction to International Relations: Theories and Approaches*. New York: Oxford University Press, 2007.
- KISSANE, Dylan, "Thinking about Power in a Complex System" (http://works.bepress.com/cgi/viewcontent.cgi?article=1023&context=dylan_kissane)
- KOŁODZIEJ, Edward A., *Securitatea și relațiile internaționale*, Iași, Polirom, 2007.
- MIROIU, Andrei și UNGUREANU, Radu-Sebastian, *Manual de relații internaționale*, Iași, Polirom, 2006.
- MORGENTHAU, Hans J., *Politica între națiuni*, Iași, Polirom, 2007.
- SCHWELLER, Randall, "Neorealism's Status-Quo Bias: What Security Dilemma?" in *Security Studies*, 5, p. 90 – 121.
- TAYLOR, Nicholas A.J., "Morgenthau or Waltz? International Relations after the Cold War"
- WALTZ, Kenneth, *Omul, statul și războiul*, Iași, Institutul European, 2001.
- WALTZ, Kenneth, *Teoria politicii internaționale*, Iași, Polirom, 2006.

NOTES:

¹ Hans J. MORGENTHAU, *Politica între națiuni*, Iași, Polirom, 2007, p.43.

² The interest, in terms of power, is, according to the second principle of political realism of H.J. Morgenthau, the main indicator that supports realism in drawing the map of the international politics. This concept makes the international politics the autonomous action and research sphere, in the same manner the interest defined as richness represents the fundamentals for economy and a higher degree of morality– ethics and religion.

See „Cele șase principii ale realismului politic” în Hans J. MORGENTHAU, *op. cit.*, pp. 44-55.

³ John M. HOBSON, *The State and International Relations*. London: Cambridge University Press, 2000, p. 17.

⁴ Randall SCHWELLER, "Neorealism's Status-Quo Bias: What Security Dilemma?" in *Security Studies*, 5, pp. 90-121.

⁵ Robert H. JACKSON, Georg SØRENSEN, *Introduction to International Relations: Theories and Approaches*. New York: Oxford University Press, 2007, p. 75.

⁶ Kenneth W. THOMPSON, W. David CLINTON, Foreword in Hans J. MORGENTHAU, *Politica între națiuni*, Iași, Polirom, 2007, pp. 21-22.

⁷ Hans J. MORGENTHAU, *op. cit.*, p. 50.

⁸ Ibidem, p. 50.

⁹ Ibidem, p. 68.

¹⁰ Ibidem, p.68.

¹¹ Andrei MIROIU, Simona SOARE, "Realismul" in Andrei MIROIU, Radu-Sebastian UNGUREANU (coord.), *Manual de relații internaționale*, Iași, Polirom, 2006, pp. 98-99.

¹² Hans MORGENTHAU, *op. cit.*, p. 74.

¹³ Lucian Dumitru DÎRDALĂ, "Kenneth Waltz și realismul celei de a treia imagini", in Kenneth WALTZ, *Omul, statul și războiul*, Iași: Institutul European, 2001, p.266.

¹⁴ Martin GRIFFITHS, *Relații internaționale. Școli, curente, gânditori*, București, Ed. Ziua, 2003, p. 77.

¹⁵ Lucian Dumitru DÎRDALĂ, "Neorealismul", in Andrei MIROIU, Radu-Sebastian UNGUREANU (coord.), *Manual de relații internaționale*, Iași, Polirom, 2006, p. 137.

¹⁶ Kenneth WALTZ, *Teoria politicii internaționale*, Iași, Polirom, 2006, p. 259.

¹⁷ Ibidem, p. 177.

¹⁸ Lucian Dumitru DÎRDALĂ, "Kenneth Waltz și realismul celei de a treia imagini", in Kenneth WALTZ, *Omul, statul și războiul*, Iași: Institutul European, 2001, p.287.

¹⁹ Martin GRIFFITHS, *Relații internaționale. Școli, curente, gânditori*, București, Ed. Ziua, 2003, pp. 92-93.

²⁰ Kenneth WALTZ, *Teoria politicii internaționale*, Iași, Polirom, 2006, pp. 258-259.

²¹ Ibidem, p. 130.

²² Hans MORGENTHAU, *Politica între națiuni*, Iași, Polirom, 2007, p. 86.

²³ Ibidem, p. 87.

²⁴ Ibidem, p. 89.

²⁵ Ibidem p. 99-101.

²⁶ Ibidem, pp.101-108.

²⁷ Hans J. MORGENTHAU, *Politica între națiuni*, Iași, Polirom, 2007, pp. 116-117.



ANALYSIS. SYNTHESIS. EVALUATIONS

²⁸ Martin GRIFFITHS, **internaționale. Școli, curente, gânditori**, București, Ed. Ziua, 2003, p. 75.

²⁹ Edward A. KOLODZIEJ, **Securitatea și relațiile internaționale**, Iași, Polirom, 2007, p. 168.

³⁰ Kenneth WALTZ, **op. cit.**, p. 177.

³¹ Ibidem, p. 179.

³² Lucian Dumitru DÎRDALĂ, “Neorealismul”, in Andrei MIROIU, Radu-Sebastian UNGUREANU (coord.), **Manual de relații internaționale**, Iași, Polirom, 2006, p. 130.

³³ Kenneth WALTZ, **op. cit.**, p. 176.

³⁴ Lucian Dumitru DÎRDALĂ, “Neorealismul”, in Andrei MIROIU, Radu-Sebastian UNGUREANU (coord.), **Manual de relații internaționale**, Iași, Polirom, 2006, p. 130.

³⁵ Nicholas A.J.TAYLOR, *Morgenthau or Waltz? International Relations after the Cold War*, najtaylor.com/?p=109

³⁶ Radu-Sebastian UNGUREANU, “Securitatea colectivă” in Andrei MIROIU, Radu-Sebastian UNGUREANU (coord.), **Manual de relații internaționale**, Iași, Polirom, 2006, p. 229.

Major General Nicolae TABARCIA (ntabarcia@yahoo.com) is the Director of the Romanian General Staff.



THE CHARACTERISTICS AND THE DYNAMICS OF THE IMMIGRATION FLOWS TOWARDS ROMANIA

Ionel STOICA

Starting 2002, and especially after 2004, the Romanian emigration started to be systematically studied by experts in different fields: sociology, economics, geography and social science - a normal step taking into account the intensity the phenomenon is being occurred recently.

Much less studied is immigration towards Romania, although this phenomenon is equally important, due to, inter alia, the responsibilities of Romania as a EU member state, especially at this moment, when the Southern European countries claim solidarity in sharing the burden of unwanted immigration (including here the refugee). In this paper the author makes a review of the current features of immigration in Romania and formulates some personal conclusions and assessments regarding the perspectives of the process in Romania.

Keywords: immigration, countries of origin, reasons for migration, pull factors, push factors, variable of migration, Romania.

1. The historical perspective of immigration in Romania

During the communist period, the entries of the foreigners in Romania were restricted because these, and especially those coming from the West, were perceived as potential threats towards the regime in place in Romania. Exception from this rule made the foreign students coming generally from the Middle East and North Africa countries. The maximum number of the foreign students was registered in 1981 and it reached 16.900, representing about 7 per cent from the total students in Romania at that time¹.

After 1990, Romania has become an area of interest for immigration flows, whose orientation towards our country has been strongly motivated by our country's perspectives of integration in NATO and EU. Permanent immigration in Romania had increased, with some fluctuations, beginning with 1991, when the number of permanent immigrants was 1,602 persons.

The largest number of immigrants was registered in 1988 (11,907 persons, by 7.4 times higher than the value registered in 1991²). In the period 1999 - 2001, the immigration stabilised around the annual cotts of 10.000 - 11.0000. In the period 2007 - 2008, the number of immigrants exceeded even that of Romanian emigrants, for the first time after 1990 (see Figure 1).

Currently, in Romania, there is no mechanism in place which to reflect the phenomenon of immigration in its whole amplitude and complexity (under all its forms of manifestation), but there are some government's institutions dealing with this issue.

Therefore, the manner in which immigrants are registered differs from an institution to another, according to the pursued aim, which put into the question the accuracy of the estimation of these flows.

Thus, the Romanian Office for Immigration (ROI) registers the number of foreign citizens on the basis of their right to stay in Romania or taking into account the authorizations for work issued by the Romanian authorities. According to this institution, the number of immigrants in Romania, both of those temporary and of those coming here for a longer period of time, has constantly increased during the period 2006 - 2008.

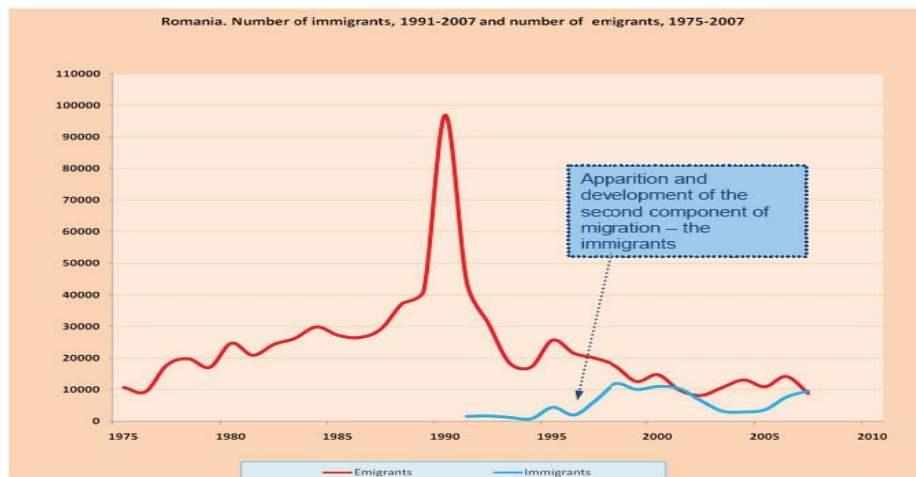

Source: Vasile Gheșău, The Known And The Unknown Face Of Romanian International Migration, International Conference "Effects Of Migration On Population Structures In Europe", Vienna, 1-2 December 2008, organizer - Vienna Institute Of Demography / IILASA

Figure 1

Table 1 - Entries of foreigners in Romania, by the type of their stay, in the period 2006-2008

Type of stay	2006	2007	2008
Temporary	42,987	52,259	69,825
Permanent	4,696	6,791	6,901
Total	47,683	59,050	76,726

Source: ROI

On the other hand, The National Institute for Statistics (NIS) registers the immigrants starting from the data provided by ROI, which it aggregates with data provided by the National System for Database Administration. This fact explains why the values provided by the NIS for permanent immigration are higher than those presented by ROI (see Table 2).

Compared to other EU countries, the immigration rate in Romania is very modest (0.4%) and we are placed right before Bulgaria (who is the last country in this regard) and at the same position as Poland, despite the constant increase in the number of the immigrants during the last years (NIS, *Permanent external migration, 2008*). However, the lack of labour force already signalled in some economic sector, the continuing increase in the demand of this factor, the numeric reduction registered in the domestic population and the ageing of this population make foreseeable an increase in the volume of the labour immigration

in Romania, for the next years. According to the Romanian authorities, during the period 2007 - 2010, in Romania there will annually arrive between 15,000 and 18,000 immigrants and the foreign stock flows will reach 200,000 - 300,000, in the period 2013 - 2015³. Such an evolution will be naturally, if we consider that in the case of other countries in the region the number of the immigrants has increased much after its accession to the EU, as well (including the number of those being illegal in these countries). The current global economic and financial crisis, which has as effect, inter alia, the substantial increase in the unemployment rate in Romania, as in many other countries as well, will not lead to a diminish in the immigration flows towards our country because the majority of the Romanians emigrants affected by this crisis will rather continue to orientate towards more developed EU countries, counting less on the possibility of getting enough money in their country.



The increasing number of foreign citizens in Romania is a consequence of the improvement in domestic economic conditions, the openness of the Romania's labour market, as well as the perspective of Romania's accession to the EU (and furthermore, materializing this perspective). Romania's accession to the EU has constituted an important stimulus for the immigrants who want to enter inside the EU area, and for whom the presence in Romania represent a first step towards the final destination - a country from Western Europe.

Immigration in Romania can also be regarded in the terms of push-pull factors, with the mention that the push factors should be regarded rather from the perspective of its symbolism (the belongingness to the international organizations mentioned above is associated with stability and security), as in the majority of cases, those involved are not attracted by the Romania's labour market, but by that of Western countries, thus, Romania representing, in many cases, a transitory space for the final destination of their international migration.

Table 2 - Number of the permanent immigrants in Romania, in the period 2000 - 2007

Year	2000	2001	2002	2003	2004	2005	2006	2007	2008
Total immigrants	11,024	10,350	6,582	3,267	2,987	3,704	7,714	9,575	10,030

Source: NIS, Statistical Yearbook of Romania, 2008

2. Countries of origin of immigrants in Romania

In Romania, the labour migration of the foreign citizens is closely linked to the possession of the work permits/authorization. In this sense, the number of the work permits issued by the Romanian authorities has constantly increased lately, as an expression of the increase in the domestic demand for foreign labour force. Thus, if in 1996, there were issued only several hundreds of work permits, in 2000 the number was 1,580 and in 2008 there were granted 15,000 work permits for foreign citizens in Romania. The total number of foreign citizens who have received work permits in Romania currently exceeds 75,000.

In the next years, it is foreseeable an increasing in the number of the work permits in order to cover the existing deficit of labour force, taking into account the increase in the demand of the foreign labour force from the side of the Romanian employee⁴.

The arguments mentioned above show that the majority of the foreign citizens within the Romanian territory come from the non-EU states. On the first 10 positions there are citizens from the Republic of Moldova, Turkey, China, Syria, USA, Lebanon, Ukraine, Tunis, Iraq and Iran. As

far as 2008 is concerned, the most immigrants came from the Republic of Moldova (19.80%), followed by those coming from Turkey (12.35%), China (9.84%), Italy (7.14%), Germany (5.5%), France (3.72%), Syria (2.65%). (Source: *Author's calculations, based on the data provided by the ROI*). Consequently, immigration in Romania has been permanently dominated by citizens from the Republic of Moldova, a country which provides between 83.88% (in 2001) and 19.8% (in 2008) from the total number of the foreign citizens who have chosen their permanent residence in Romania.

Immigration from the Republic of Moldova towards Romania, supported by the historical links and a common language, has intensified after the adoption of the Romanian Citizenship Law⁵ which, in fact, defines the Moldavians migration as a form of repatriation, specifying that the descendents of the former Romanian citizens can regain the Romanian citizenship, on their request, even if they do have another citizenship or they do not live in Romania.

At the same time, immigration from the Republic of Moldova has increased due to the increasing demand for labour force in the Romania's agriculture, after the recently massive emigration of the Romanians from the rural areas.



Immigration from the Republic of Moldova towards Romania is also continuing after the Romania's accession to the EU, but after this moment, Romania has introduced compulsory visas requirements for the Moldavian citizens, aspect that generated a substantially increase in the number of the Moldavians citizens who applied for the Romanian citizenship prior to this moment. It is estimated that 500,000 Moldavian citizens (if we add the children, the number reaches 800,000) applied for the Romanian citizenship beginning with 2007 and it is foreseeable that their number could exceed 1.8 millions (from the total number of 3.8 millions persons living in this country) until the end of the 2009⁶.

The main fields of activities of the immigrants in Romania are: trade (wholesales and retails), textile industry, services and the financial sector.

After 1990, immigration in Romania has registered a more dynamic, and largely different (including under the motivations' aspect), evolution from that registered prior to that period. While during the period of 1990s, the majority of immigrants in Romania were persons coming from the Middle East, Turkey and China, recently, since the privatization of the Romanian economy and due to its increasing integration into the global economy, the number of the citizens coming from the EU member states and who decided to work and live in Romania, permanently or temporarily, has increased.

Even if on the first positions as far as the number of the immigrants is concerned, we meet states from outside the EU area, in the last years we may notice an important increase of those coming from the EU member states.

In the period 2006 - 2008, the share of those coming from the EU member states has increased constantly. Thus, while in 2006, 20.37% from the total number of the foreign citizens came from the EU member state, in 2007 their share increased at 26.54% and in 2008 their share was 29.97%. The explanation consists of the fact that once the delocalisation process targeted Romania, the multinational corporations brought the needed personnel in running its activities, as well (at least as far as the top managers are concerned). In this sense, it is worth mentioning that from the total number of the active work permits issued in 2006, 29.9% targeted the leading positions (*Source: Office for the Labour Force Migration*).

In many cases, the delocalisation in Romania, as in other countries in the region, has targeted labour intensive activities (in Romania, however, at the higher rate than in other countries in the region⁷).

It is also observable that on the first positions related to the number of the immigrants, between the countries from within the EU space, are, in the broad lines, the countries that have the highest levels of the foreign direct investments in Romania (Italy, Germany, France, Austria and Hungary⁸).

A special attention draws the substantial growth, within an interval of only two years (2006 - 2008), of the those coming for labour from Italy (from 2,907 persons in 2006, to 5,479 in 2008), Germany (from 1,767 in 2006, to 4,216 in 2008), France (from 1,413 persons in 2006, to 2,858 in 2008), Austria (from 425 persons in 2006, to 1,501 in 2008), The United Kingdom (from 681 in 2006, to 1,331 in 2008) and Hungary (from 214 persons in 2006, to 1,337 in 2008; *Source: ROI*).

3. Immigrants' motivations

The shifts registered in the dynamics of the immigration not to refer only to the countries of origin of the immigrants, but also their motivations and the variables of the immigration process.

Thus, while during the communist period, the majority of the foreign persons in Romania were students and only a small part of them were businessmen, currently, the range of the immigrants motivations is much more diversified. Those arrived for studies continue to represent the largest part, but the number of those coming for work has increased pretty much, as well.

At the same time, many new motivations have appeared, some of them are based on the Romania's status, as a EU member state (for instance, the right for reunification of the family could be invoked and used by an increasing number of the persons), others being a consequence of the globalisation and of the increasing interest of some international/humanitarian organisations (whose aims in Romania are not always transparent enough or, in any case, they do not fully correspond to those declared) for our country.

We present bellow a list of motivations for the presence in Romania of the foreign citizens, as it was established by the ROI (see Table 3).



Table 3 - Number of foreign citizens having the staying right available, by the aim of coming in Romania, 2006-2008

Motivation for staying in Romania	2006	2007	2008
Studies	11,036	10,716	10,576
A member of the family is a Romanian citizen	7,786	11,97	17,093
Reunification of the family	4,98	3,32	3,209
Commercial businessmen	7,708	5,509	3,815
Employment on labour market	5,504	5,00	8,821
Religious or humanitarian activities	1,06	1,81	1,093
Specialization	850	892	1,090
Ph.D. candidate	173	189	194
Activities related to school	16	7	2
Medical treatment	...	1	...
Science & Research activities	2
Other professional activities	27	20	18
Other aims	3,483	2,507	4,446
TOTAL	47,683	59,050	76,726

Source: ROI, 2009

Even if this delimitation has some lacunas (if we take into account that those belonging to a family in which one of the member is Romanian citizen may be as well employed in the labour market - it appears thus a redundancy of the motivations), it provides a detailed image upon the motivations spectrum and upon the relative importance of these motivations.

4. Variables of the immigration process in Romania

The changes in the dynamics of the immigration flows aimed both quantitative and qualitative aspects, the last being expressed by using variables such as: age and gender of the immigrants, their educational level and their distributional spread within Romania's territory.

In order to understand the consequences of the actual immigration's dynamics in Romania and to properly assess the impact of these consequences upon the Romanian society, both on short term and especially on long term, it is necessary to examine the evolution's trends of each of these variables.

a) Age of immigrants

Immigrants in Romania are, in general, adult persons, with a high potential for integrating into the

labour market (NIS, *Permanent external migration, 2008*). According to NIS (*Statistical Yearbook of Romania, 2008*), the share of immigrants under 25 years old and those 61 years old and more has reduced within the last decade, being associated with the increase of those between 26 and 60 years old (see Table 4 and Figure 2).

In the last decade, the share of persons under 25 years old did not exceed 37% for none of these years. This suggests a possible reduction in the number of those coming in Romania for studies. Also, neither the per cent of those between 51 years old and more did not exceed 22% from the total number of the immigrants (the lowest share - 21.83% being registered in 2004). The most important segment of the immigrant's population was represented by the persons between 26 and 50 years old. This category, which presents the biggest interest for the Romanian labour market, has registered, in the last decade, shares of 50 - 59% from the total. The increasing share of labour migration represents the explanation for the increase registered at the level of the active group population.

These trends are in concordance with the motivations of the immigrant's presence in Romania and presented.

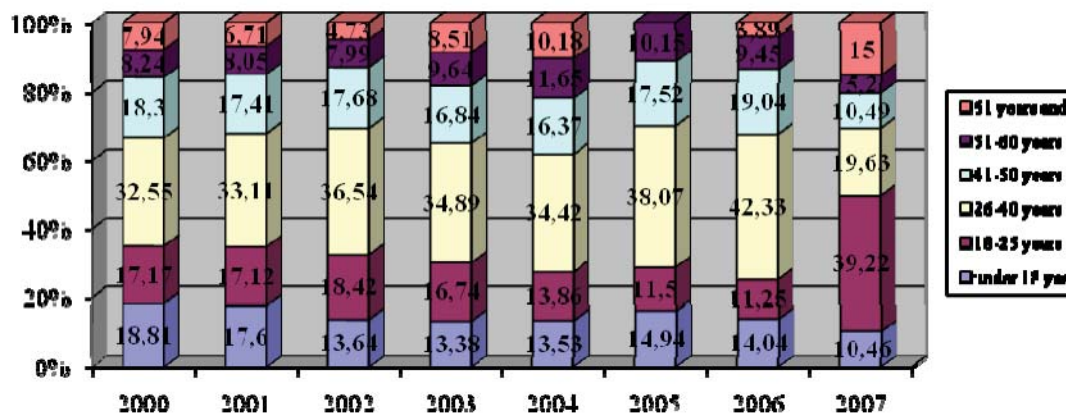

Table 4 - Variation of the structure of immigrants by age group

Age group	Structure of immigrants, by age group (in %)							
	2000	2001	2002	2003	2004	2005	2006	2007
Under 18 years	18.81	17.60	13.64	13.38	13.53	14.96	14.04	14.98
18 - 25 years	17.17	17.12	19.42	16.74	13.86	11.50	11.25	10.46
26 - 40 years	32.55	33.11	36.54	34.89	34.42	38.07	42.33	39.22
41 - 50 years	18.30	17.41	17.68	16.84	16.37	17.52	19.04	19.63
51 - 60 years	8.24	8.05	7.99	9.64	11.65	10.15	9.45	10.49
≥ 61 years	7.94	6.71	4.73	8.51	10.18	7.80	3.89	5.22

Source: Author's calculation on the basis of the data from The Statistical Yearbook of Romania, 2008

Figure 2 - The structure of immigrants, by age groups



Source: Author's calculations on the basis of the data from Statistical Yearbook of Romania, 2007

b) The immigrants' gender

In Romania, the structure of the permanent immigrants has registered important variations from a year to another, alongside the period 1991 - 2008.

Initially (in 1991), the female's share was overwhelming (63.7%), but after that, this

characteristic has disappeared, the male's immigration becoming prevalent and maintaining thus in all the others years from the interval 1991 - 2008 (see Table 5; Figure 3). The lowest share of the female in the total number of immigrants has registered in 2008 (32.82%, according to ROI).

Table 5 - Structure of the immigrants, by gender, 2000 - 2007 (%)

Gender	Year							
	2000	2001	2002	2003	2004	2005	2006	2007
Male	50.91	51.25	51.87	53.44	56.58	57.15	61.73	61.32
Female	49.09	48.75	48.13	46.56	43.42	42.85	38.27	38.68

Source: Author's calculations, on the basis of the data from Statistical Yearbook of Romania, 2008

Figure 3 - The structure of the immigrants, by gender and age, 2000 - 2007

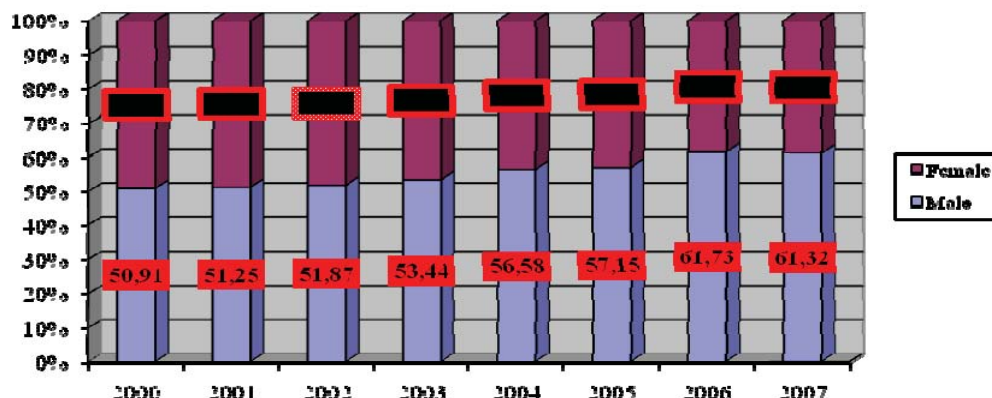

Source: Author's calculations on the basis of the data from Statistical Yearbook of Romania, 2008

The same trend in the reduction of the female's share in total number of immigrants results also from the data provided by ROI, although the figures are slightly different.

Table 6 - Structure of the immigrants, by gender, 2006 - 2008 (%)

Gender	Structure of the immigrants by gender, 2006 - 2008 (%)		
	2006	2007	2008
Male	63.15	64.91	67.18
Female	36.85	35.09	32.82

Source: Author's calculation on the basis of the data provided by ROI

The female immigration is explained by the increasing demand for labour force in the textile industry and agriculture, the raise in the migration for business (here we refer especially to the immigrants coming from Turkey, those of Arab origin, or Chinese) and the extension of the delocalisation of the multinational corporations' activities in Romania. Once the business became stable, the businessmen proceeded to the reunification of family, which increased share of female in the total immigrants. In particular, for female immigrants coming from the Republic of Moldova, the gender distribution is more equilibrated related to the general situation, aspect determined by the important presence of the female from this country in the agriculture sector from Romania.

c) Educational level of the immigrants

The structure of the immigrants after the educational level has registered low intensity changes during the last decade. The increase with 12% of the share of immigrants with high school level of education, which reaches about 46% from

the total in 2008 (Table 7 and Figure 4), as well as the increasing share of those with university studies (around a quarter from the total number of immigrants registered in 2008), in the detriment of those with gymnasium and elementary school, retained a special attention.

As far as the educational level of the foreign citizens coming in Romania for work is concerned, a statistics of the Ministry of Education, Research and Innovation (through its subsidy, the National Center for Recognition and Equivalence of Diplomas) reveals the following aspects⁹:

- the total number of the foreign citizens who applied for the recognition of their diplomas between 2003 and 2006 (from January to April, for the last year) is of 5,174, of which 795 (15.37% from the total number) applied for the recognition of university diplomas, the rest of 4,379 (84.63% from the same total) applying for the recognition of high school diplomas;

- as for the applications for the diploma recognition for the foreign citizens coming from the EU countries, it can be noticed that on the first five positions are: France - 350 requirements (6.76%



ANALYSIS. SYNTHESIS. EVALUATIONS

from the total), Germany - 218 requirements (4.21%), Italy - 173 requirements (3.34%), The United Kingdom - 149 requirements (2.88%), and Greece - 107 requirements (2.07% from the total);
 - from the analysis of the requirements for the recognition of university diplomas, if we take into

account their total number, the EU countries with the most applicants are: France - 217 requirements (27.3%), The United Kingdom - 132 requirements (16.6%), Germany - 117 requirements (14.72%), Greece - 64 (8.05%) and Austria - 56 requirements (7.04%).

Table 7 - Structure of the immigrants, by the education's level (%)

Education's level	1995	2000	2005	2008
University studies	18.98	22.49	20.36	24.98
High school studies	29.79	34.39	43.93	46.27
Vocational and technical studies	11.91	11.60	6.80	3.23
Gymnasium and elementary	27.88	23.21	21,57	16.43
Other situation	11.44	8.31	7.34	9.1

Source: Author's calculations base on the data from Demographic Yearbook of Romania, 2007 and 2008 editions; Permanent external migration, 2008

Figure 4 - Structure of immigrants, by educational level (in %)

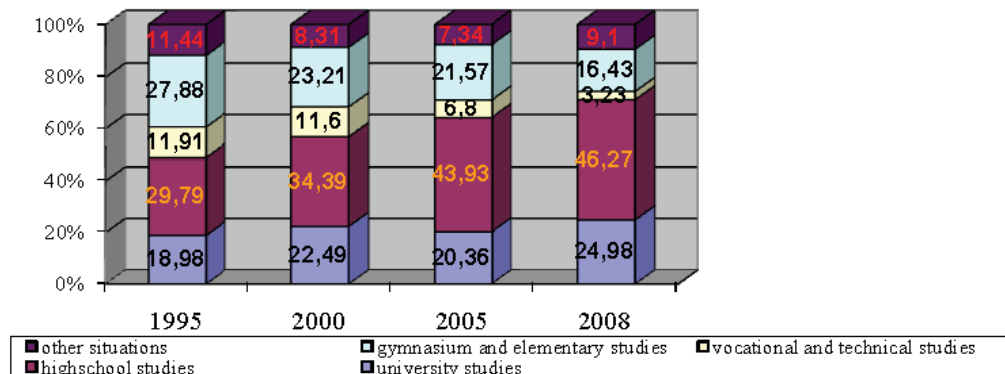

Source: Author's calculations base on the data from Demographic Yearbook of Romania, 2006, and Permanent external migration, 2008

d) The immigrants' distribution by the residence area in Romania

According to the NIS (*Permanent external migration, 2008*), around half (50.18%) from the total number of the permanent immigrants in Romania are unmarried; the majority of them (90.94%) have chosen the urban area for their residence. The immigrants' communities in Romania are localised especially in the largest cities. For some immigrants, it can be noticed an orientation's trend towards certain geographical

areas.

Thus, in Iasi we can meet especially citizens from the Republic of Moldova; in Cluj, it is interesting to signal the existence of a Japanese immigrants' community and in Craiova there is a strong foreign community, dominated by the Arab students.

The most important small commercial towns are controlled by them. The Arabs set up transportation companies for merchandise and persons, exchange offices and construction companies.¹⁰

The foreigners who have chosen their permanent or temporary residence in Romania have preferred the most development economically areas as well as the university centres.

Table 8 - Top five counties, by the number of immigrants

County	Immigration proportion (%)		
	2006	2007	2008
Bucharest and Ilfov county	45.55	43.98	43.05
Iasi	6.07	5.56	5.51
Cluj	5.65	5.65	5.33
Timiș	4.84	5.05	5.10
Constanța	4.55	4.01	4.50
Total	68.00	64.25	63.49

Source: Author's calculations on the basis of provided by ORI

Figure 5 - Distribution of the immigrants by development region, 2008

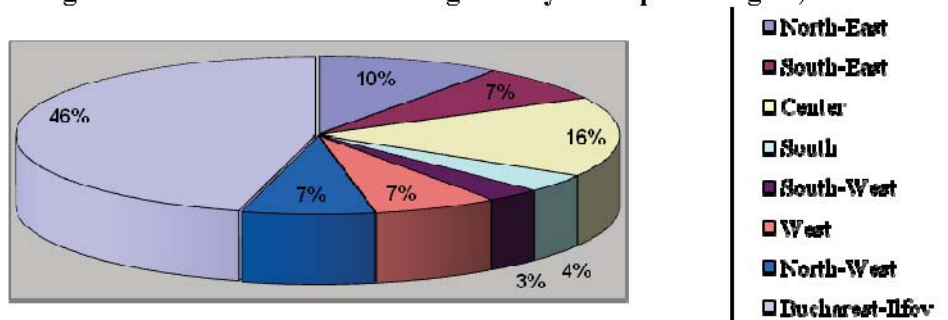

Source: Author's calculations after NIS, Permanent external migration, 2008

From the table above we notice that almost two thirds from the total number of the immigrants have chosen Bucharest and other five counties. For 2008, the largest number of foreigners were registered in Bucharest and Ilfov county (33,032), followed by the Iasi county (4,230), Cluj county (4,090), Timiș (3,914) and Constanța (3,454).

Even before 2008, the Bucharest - Ilfov area definitely dominated the immigrants' preferences hierarchy, being placed at the large distance from the others development areas within the country. More modest flows of immigrants are currently registered in the South - West area - Oltenia.

Conclusions

From the data above presented, we can assess that from the perspective of age, gender, educational level and distribution within Romanian territory,

immigration flows have an uneven repartition. A current profile of immigrants in Romania would be as it follows: young persons under 40 years old, both male (who predominate) and female, with high school studies (although those with university studies are not missing), who establish their residence in the large cities.

The foreign citizens afflux in Romania is still modest compared to the Romanian's massive emigration towards West and it will continue to be strongly dependent to the attractiveness of the Romanian economy (it will depend to the pace with which this economy will manage to reduce the distance to the developed economies within Europe). This situation of Romania is not a new one in this regard, if we take into account that countries like Greece, Spain or Portugal registered large migratory flows after five years from their accession to EU (on the other hand, Cyprus was



already getting massive immigrants flows, after only a year from its accession to the EU).

Most probably, immigration flows in Romania will have two main components: one from the poorer neighbouring countries (especially from the Republic of Moldova and Ukraine), who take advantage either of speaking the language, either of the geographical closeness or the more permissive customs regime, and those coming from certain Asiatic countries (especially Chinese, Vietnamese, Arabs, Afghans, Pakistanis and Indians). Regardless of the geographical area from which they come from, immigrants will try to use the Romanian territory as a transition point towards Western Europe¹.

In this circumstances, it is likely that the South and North-East areas in Romania, predominantly agricultural, to get an increasing number of workers from the Republic of Moldova and Ukraine; at the same time, the Asiatic immigrants will orientate towards urban areas, where, most probably, they will work in construction sector, textile industry, trade and services.

Both those coming from the Eastern Europe and those from Asia will be involved in illegal activities (drugs traffic, human trafficking or smuggling, robberies and thefts), if they will not be able to make a living. In the majority of the cases, it is expected that immigrants to establish their residence in the neighbourhoods of the large cities or in the localities close to these cities, where the rent costs are more accessible. It cannot be excluded also the appearance of some illegal constructions, as those where some of the Romanian emigrants live in the Western countries.

REFERENCES:

1. Hunya and Anna IARA, *Impact of Romania's Accession to the EU on the Austrian Economy*, A study commissioned by the Romanian Embassy in Vienna, Vienna, March 2006.

2. GHEȚĂU Vasile, *The Known And The Unknown Face Of Romanian International Migration*, International Conference "Effects Of Migration On Population Structures In Europe", Vienna, 1-2 December 2008, organizer - Vienna Institute Of Demography / IIASA.

3. *Fenomenul migraționist din perspectiva aderării la UE*, Institutul European din România

(2004), www.ier.ro

4. Focus Migration: Romania, <http://www.focus-migration.de/Rumaenien.2515.0.html?&L=1>

5. *Liberalization of labour market in Romania*. Impact study realized by Department for Labour Abroad, Office for labour force migration and Faculty of Political Science and Communication Science, University of Oradea, 21 November 2006, Second edition.

6. Statistical Yearbook of Romania, 2007 and 2008 Editions (National Institute for Statistics).

7. Permanent external migration, 2008 (National Institute for Statistics).

8. Romanian Office for Immigration.

9. *Capital magazine*, 14 November 2005 edition.

10. *Gândul newspaper*, 15.08.2008, *Ungurii muncesc în România pe jumătate din banii ceruți de localnici*.

11. Mediafax, 30.10.2008.

NOTES:

¹ Focus Migration: Romania, <http://www.focus-migration.de/Rumaenien.2515.0.html?&L=1>.

² Source: Statistical Yearbook of Romania, 2007 and 2008; Permanent external migration, 2008, National Institute for Statistics.

³ *Capital magazine*, 14 November 2005.

⁴ Only between January 1st and September 19th 2008 there were 13,699 requests from the Romanian employees in order to deliver new labour permits. From all of them, 10,000 requests were approved, 1,880 were rejected and other 1,819 were being in the course of resolution (Source: Mediafax, 30.10.2008).

⁵ As a consequence of this law, it is assessed that more than 250,000 Moldavian citizens have received the Romanian citizenship during 1990s. Under these circumstances, the official number of the Moldavian citizens in Romania could be higher in reality than presented by the official statistics, because of the fact that Moldavian citizens who have gained the Romanian citizenship are not registered officially as immigrant, but as Romanian citizens.

⁶ Focus Migration: Romania, <http://www.focus-migration.de/Rumaenien.2515.0.html?&L=1>.

⁷ For instance, the Austrian companies in Romania employ a person for a stock of 37,500 euros. In other countries from the region, this figure is almost double: in the Czech Republic - 58,100 euros, in Hungary - 64,200 euros (for details, see Gábor HUNYA and Anna IARA, *Impact of Romania's Accession to the EU on the Austrian Economy*, A study commissioned by the Romanian Embassy in Vienna, Vienna, March 2006).



⁸ In the case of Hungary, the presence in large number of the citizens coming from this country is explained through that an increasing number of the Hungarians originated from the Eastern Hungary – a poor area having a high rate of unemployment – come in Romania, either on their own, or being recruited by the Hungarian companies operating in Romania, where they earn better salaries than in their country of origin. They work especially in the construction sector, suffering from an acute deficit of labour force as a result of the massive emigration of the Romanian towards other states (Source: *Gândul newspaper*, 15.08.2008 edition, *Ungurii muncesc în România pe jumătate din banii ceruți de localnici*).

⁹ *Liberalization of the labour market in Romania*. Impact study realized by the Department for Labour

Abroad, Office for labour force migration and Faculty of Political Science and Communication Science, University of Oradea, 21 November 2006, Second edition.

¹⁰ Capital magazine, 14 November 2005.

¹¹ According to the Border Police, in 2001, 3,577 foreign citizens were captured while trying to enter or exit the Romanian territory alongside the Green Area of the border; three years later, the number of foreign citizen trying to pass the Romanian border reduced to 622. The majority came from India, China, Iraq and Pakistan. At the same time, the number of the attempt of passing the border on the basis of false ID cards has increased, especially from the side of Moldavian, Turks, Ukrainian and Chinese citizens.

Major engineer Ionel STOICA(jstoica2001@yahoo.com) works as an analyst in the politico-military field within the Romanian General Staff. Licensed in technical field (Military Technical Academy, Bucharest) and economics (University Lucian Blaga, Sibiu), he is a PhD candidate at Geography Faculty, University of Bucharest. He is also author of some papers on national and international security, published in Romania or abroad, and is especially interested in international migration field.



A POSSIBLE SOLUTION: A SYNERGIC PONTIC-MEDITERRANEAN CONTINUUM

Grigore ALEXANDRESCU, PhD

During the evolution of the whole European civilization, the Black Sea and the Mediterranean Sea have been tightly connected not only by waters, but also by their peoples' common fate. It has determined the scene to generate a synergic effect in the Euriasian and Eurafrican relation. Therefore, on both shores, there have been achieved confluences sheltering the civilisations' essences developing in this part of the world and building some indisputable systems of values.

Today, guiding ourselves after the history's lessons, EU may stimulate the achievement of a synergic continuum from the Mediterranean Sea to the Black Sea, for providing a larger and more flexible dialogue framework, one that should give coherence and substance to the policies addressing the area. This mechanism may work for turning into dynamic the current regional cooperation process, by an intensified dialogue which should increase the trust of the states from these three continents.

Keywords: synergy, the initial geo-physical platform, Barcelona Process, Euro-Med Partnership, the Synergy of the Black Sea, the Eastern Partnership, the regional security.

Seas and oceans are, in essence, immense fluid spaces separating, identifying and uniting continents and civilizations, meantime stimulating the development of large scale geopolitical constructions. Mostly, world's seas and oceans are international waters, nobody's and everybody's waters, bordered by territorial waters, continents and countries.

During millennia, seas and oceans have not only separated human communities, but they have also reduced their mobility. The continuous movement of the populations from East to West occurred in stages and generated (and continues to generate) conflicts and rejection reactions, but it cannot remodel substantially the configuration

of civilizations; it just feeds its tension and dynamics.

Nowadays, *nolens-volens*, world's seas and oceans have become bridges not only between international actors, but also between their political, economical, cultural, military interests and between their interests of any other nature. Therefore, one could state that, lately, the large spaces of water gained an extremely important function within the era we are living in, within the era of the evolution of the human kind towards globalization – *the synergic function or the synergic effect*.

One could ascertain that the first concretization of this function has the Atlantic Ocean as a coagulant. During time, especially as a consequence of the two World Wars, the Atlantic Ocean generated, through its synergic effect, a Euro-Atlantic dimension, and Euro-American synergy, materialized in an accelerated and very consistent technological and cultural evolution of the two shores of the ocean. Besides, in our opinion, it is also the sole large scale geopolitical and geo-strategic synthesis achieved so far. It is formed by a concretization of an *offshore* pattern, through which the ocean allows the connection of two power effects. On one hand, there is the European power effect which appears as a remnant effect of a generative power, as the European expansion engendered today's America. On the other hand, there is the American effect, as America, especially USA, produced the technological and informational power which represents nowadays a very consistent civilization matrix for the age of the knowledge based society, for the age of globalization. This doesn't mean necessarily that the globalized human society will look like the United States of America at present; it just implies that the synthesis effect produced by the Euro-Atlantic relation, corroborated with the Asia-Pacific synthesis effect and with the Eurasian and Eurafrican, ones will constitute the fundament of a new type of civilization.



ANALYSIS. SYNTHESIS. EVALUATIONS

For the time being, the Euro-Atlantic dimension is the sole synergy of this type realized on our planet. Nevertheless, it is possible for the Arctic Ocean to stimulate another synergy. The numerous resources covered by the ice cap would determine not only the riparians but also the others to collaborate and cooperate for prospecting, assaying and exploiting them.

Here is the proof that the synergic effect of seas and oceans will not lose its importance in the following years. Probably, it will be the main binder of the geopolitical and geo-strategic connections and games which will accompany human society in the next decades.

Europe must generate, maintain, develop and capitalize at maximum the synthesis effect in all the areas that bring and will bring advantages, in order to permit facts to evolve on these coordinates.

From the multitude of these areas, we set ourselves to focus on the southern and eastern areas of the European construction, through *the Eurafrikan and Eurasian synergic effect*. This focus is required by two important reasons:

- EU, together with Russia, Japan, China, India, Turkey and states from the Middle East, has the necessary means for getting rid of the prejudices and realize the Eurasian unity, which is, in our vision, a geopolitical, geo-economical (especially energetic) and multicultural, multi-civilisational entity, but which can turn into an integrated type entity, similarly to the Eurafrikan complementarity, which is absolutely necessary for the security of the actual geographical configuration of the initial geophysical platform (Asia, Europe, Africa);

- Only such a unity is and will be able, together with the Eurafrikan and Euro-Atlantic complementarity, to engender world's security and its sustainable development.

Even if, at present, these dimensions of the European policy are somehow distinct, they could be easily assembled as a whole. The Mediterranean and the Black Sea, interior seas of the Eurasian and Eurafrikan space, become, in this new era, intercontinental and intercultural bridges and binders. Both seas - tightly bounded during the whole evolution of the European civilization -, have always been a space with a synergic effect for the Eurasian and Eurafrikan relation. This effect has determined, on both shores, the achievement of confluences encompassing the substance of the civilizations that succeeded each other on these

places and of the settlement of indisputable value systems.

Nowadays, Southern Europe brings in a fair return in the advantage of the whole European construction – the relation with the Asian and African states. As a matter of fact, such a relation is still under reconstruction. But it was once – in the age of Greek and Roman civilizations– the vital core of the European development. Nevertheless, during those times, there wasn't a Euro-Atlantic dimension. As such dimension, whose fundament was laid ever since Renaissance and amplified by the development of the naval means of transport, became increasingly durable, the synergy of the Mediterranean and Black Sea grew blurred, but they have not disappeared, they have just passed in a secondary plan.

It's high time for those old synergies to be revived. Their effects will be, first and foremost, as beneficial as possible for the adjoined countries, but also for the remote ones. Indeed, the millennia of wars and conflicts which have tormented and have divided these immense spaces haven't yet ceased to produce consequences and the new challenges, menaces and risks are added to the already existent vulnerabilities, engendering multiple risks. And Europe must assume these risks. But they could be mitigated and even eliminated. From this point of view, a possible method could be the generation of synergic effects in the contact and confluence spaces. Thereby, the areas of strategic faults, which separated and opposed states, regions and individuals, could become areas of strategic confluence. And this represents an important objective of the knowledge-based societies.

The gradual enlargement of NATO and EU brought both alliances at the shores of the Mediterranean and Black Sea, generating new challenges for them.

Regions with political, economic, strategic, civilisational specific features required specific approaches. There was a need for distinct cooperation programs – Barcelona Process, Euro-Mediterranean Partnership (Euromed) for the southern part and Black Sea Synergy and Eastern Partnership as far as the oriental part is concerned.

But, after having analyzed more closely the issues which both the regions have to cope with, one could notice that many of them are similar. Terrorism, organized crime, illegal migration,



ANALYSIS. SYNTHESIS. EVALUATIONS

arms, human, drugs trafficking, the proliferation of weapons of mass destruction are trans-national threats monitored by most of the countries. Considering the trans-national character of the new security threats and risks, the geographical proximity of the Mediterranean and Black Sea, their interdependence, and the fact that the only passage out from the Black Sea to the Planetary Ocean passes through the Mediterranean Sea, we consider that there is necessary a common approach of the challenges that these seas bring into the international scene and the elaboration of similar solutions. Moreover, common approaches and solutions reveal to be even more necessary, as both seas under discussion are part of the same strategic arch bordering the large constructions which identify today's Europe: NATO and EU.

One of the solutions which we consider to be successful is the construction of a *synergic continuum* from the Mediterranean Sea to the Black Sea. This could be focused on the coordination of the various policies and initiatives developed on the scene by the riparian countries and by the interested international institutions. Black Sea Synergy, elaborated by EU, in April 2007, could be considered a study laboratory.

Briefly, Black Sea Synergy synthesizes EU's vision on the cooperation with the adjoining states. It doesn't set itself to constitute a new independent strategy of the Union for this region. This is because, in time, EU has elaborated a series of policies regarding this area: European Neighbourhood Policy (ENP), which addresses the new independent states, the pre-accession strategy for Turkey, the Strategic Partnership with Russia. Black Sea Synergy should be rather looked upon as a complementary initiative to those policies with focus on the regional level. It is a complementary effort to these policies which is meant to strengthen the cooperation between the states adjacent to the sea and between these states and EU.

From this point of view, by realizing a synergic continuum to the Mediterranean and Black Sea, EU

could ensure a wider and more flexible framework of dialogue, which could increase the coherence and could better orientate the policies addressing this region. This mechanism could also be used in order to stimulate the present regional cooperation process through an increased dialogue that could contribute to the growth of the thrust between the countries from the three continents.

The challenges that the riparian states of the Mediterranean and Black Sea have to cope with could find here the ideal place to be debated and solved through an integrated approach at a Euro-Afro-Asian level.

Economically, both regions could be looked upon as bridges between continents, important and viable commercial routes and means for enabling the sustainable economic, social and political development.

Moreover, both seas are *transport routes* ideal for providing the rapid connection between continents. This fact could be reckoned as an advantage (if we took into consideration the possibility to re-evaluate them economically, energetically and militarily) or as a disadvantage, if we considered them from the possibility to be used as gateways to the Euro-Atlantic space by the transnational organized crime networks or by the terrorist organizations.

Therefore, *the security and defence dimension*, where the synergic continuum achieved by all the adjoining states, could, beyond any doubt, assure the stability and peace in the Mediterranean-Pontus Euxinus space.

As a conclusion, in order to realize the security, stability and welfare in the great scene of the original geophysical platform, it is necessary to harmonize and increase the efforts of the Europeans, Asians and Africans to realize new and sustainable relations at the Mediterranean Sea and the Black Sea. It's high time to quit the ghosts of the past and to lay the fundament of a new future in which, synergizing contact, confluence and connection spaces occupies a well-deserved place.

Col. (ret.) Grigore ALEXANDRESCU, PhD (grigalex@yahoo.com), is a scientific researcher, author or co-author over 40 monographs, studies and specialty papers. He published over 130 articles in prestigious security, strategy and military history magazines from Romania and abroad. He graduated a number of courses organized by Euro-Atlantic educational institutions and participated in stability and support operations.



THE CULTURAL DIFFERENCES BETWEEN THE MILITARY AND THE SOCIETY

Grațiana VLĂDĂIANU

The article intends to ask, in a rightful manner, some questions about the place that the military forces and structures take in the social system, the manner they interact with the society they are called to protect. What is the military's purpose in the Romanian society? Do the military forces develop cultural differences or similarities regarding the Romanian society? Is the military a part of the society or a distinct entity? And how do we operate with those concepts, as the contemporary world is crossing an unprecedented identity crisis and the doctrinaire movement has to readjust quickly the concepts becoming without questions a must have to their survival.

Keywords: military, society, civil-military relationships, social system, military culture, organisation, subculture, control, the theory of divergent, the convergence theory, military tradition, the country cult, the feudal elites, the military phenomenon, war, ritual, investigation, sociological research, officer corps, the supreme sacrifice, globalization, nation, specificity.

The contemporary society comes across a series of dramatic changes regarding the structural level, changes which drive it directly into an identity crisis, as never seen before. The doctrinal movement has to keep up with this stunning evolution as well. As a result, readjusting the doctrines and redefining their concepts become a must in order to survive. Which is the position of the National State regarding the process of globalization? How can we finally solve out the dilemma of the security? And actually, whose security: the person's or the security of the state and the society? The closed society or the "Open Society", as famous Popper¹ used to call it? What about liberty versus security? What kind of future can we foresee for liberty? What is there beyond the liberalism and conservatism? Do the doctrines answer better to the call of society? Will the twenty first century

proclaim the end of the history, using the famous expression of Francis Fukuyama²? All of them are questions to which the scientific research should answer, observe the trends, redefine the concepts and finally to make action plans for the society.

The Romanian scientific community's efforts of initiating completely new domains of research for the intellectual horizon in our country stand for as an example. The research of the existing reports between society and military structure is undoubtedly a new line of work, but nevertheless, it is growing stronger because once with the fall of the communism, Romania returns to democracy and after long efforts succeeds in integrating into the Euro-Atlantic structures and becoming a member of NATO and UE with full rights.

In my opinion, a pertinent study of the cultural differences between the military and society should begin with defining the social system, then framing the military within it: military is a part of society and it is definitely not a distinct entity. Its primary concern is to defend the society, action which obviously gathers an amount of objective and subjective factors, a complex of specific characteristics which makes us distinguish a series of cultural aspects concerning the military. Whether these aspects are part of the culture or of the subculture, or, on the contrary, they remain just simple differences which do not affect or change the form and the background of the society culture, this is a problem which the Romanian sociologists have approached in different papers³.

That is why this paper is more like a sketch work, a proposal of synthetic approach of the military versus society dilemma, trying to ease and fasten the comprehension of its subtleties, all with certain logic and a certain dynamic, so as its analysis may serve as a ground start for an optimal fulfilment of the military's fundamental mission, which is serving and defending the society.



Fundamental questions of sociology: what is society? What is culture? What is the position of the Armed Forces' in the social system?

Closely studying the concepts of culture and society, Anthony Giddens states that there are variously common points among these concepts, they are still very distinct: "Culture refers to the ways of life of the society's members or groups belonging to a society. It refers to the way they dress, wedding and family traditions, their work style, religious ceremonies and the way people spend their spare time. 'Culture' can be different in a conceptual way from 'society', but they are very tight connected. Society represents a **system of inner connections** which relates one individual to another.... There is no culture without society, as well as there is society without culture. Generally speaking, we wouldn't be humans without culture. We wouldn't have a language, wouldn't owe self-conscience, and our ability of thinking and judging would be extremely limited."⁴

Lisette Coandă follows the same idea, and referring to George Simmel⁵ and his contribution to the sociological research, writes that the German sociologist starts the study of society from the idea that society is a "... product of the individual connections between social units (persons, groups)", and "... each type of connection has a social dimension and it even has a role in building the society. In other words, next to crystal and stable structures, such as state, family, church, social classes and organizations based on common interests, there are also many other forms of relations and connections, parts of bigger social organizations, without which society could no longer exist. In George Simmel's point of view, society is not a 'substance', something definite, but an 'event'. It consists of all actions and influences which individuals take and give among each others, no matter whether they are aware of it or not. The world can be better understood in terms of conflicts and contrasts between opposite categories: the condition of life itself is the coexistence of the totally opposite elements."⁶

A systematically approach of the social concept can be seen both in studies from the nineteenth century, showing a pioneer characteristic — the term of sociology is just being invented by Auguste Comte (1798-1857) who considered it "the last science research that derives from

physics, chemistry and biology, but also the most complex and the most important of all ..."⁷, science which "...should contribute to the wellbeing of the community"⁸, and by using this "... the understanding, foreseeing and observing of the human behaviour"⁹ become possible —, and in referential studies of the twentieth century.

Alexandru Radu, in his studies on the contemporary political phenomenon, writes that "although the term of system is one of the oldest in the tradition of the European way of thinking (the first systematic research is dated even from antiquity — the Aristotelian philosophical system - n.b.), the systematically theory was born only throughout the middle of the twentieth century, at the same time with the paradigm of complexity. The traditional scientific thinking crisis on one hand and the overwhelming trends on the other hand were the generating conditions of a new theoretical approach of the social concept and of the world, based on multidisciplinary and redefining."¹⁰

So, studying and analyzing the social phenomenon and the relations between military and society using the general theory of systems do not take place by accident, and it is also successfully done by the military sociologists: "... society is an organized way of existence among life's phenomena, which implies the community existence of individuals who are part of more or less persistent organizations. Life within human society represents the system characteristic for all its levels of organization: individual, family, different types of groups, institutions, cities, global society and humanity. There can be established relations of guidance, mutual influence, competing or cooperation between these levels of organization, called subsystems."¹¹

From this point of view, the social system is made out of subsystems: the state and its institutions, the civil society, the political society, parties and political organizations, the latter being seen as a connection between the subsystem of the civil society and the one of the political society, all three of them make possible the efficient functioning of the state's subsystem. The place of the armed forces on this map is in the state's subsystem, being its subordinate.

But we can also elaborate a different dividing of the social system, the military and the rest of the society, that part of society which is identified as being civil, meaning that it does not wear the



symbols of the military authority (such as the uniform) and does not obey the military discipline. This is for sure a trivial approach of the discussed matter, even too simple, because what we call civil society forms the subject of a specialized analysis, a much more complex one and obviously much more expressive: “the term of ‘civil society’ refers to voluntary ways of combining the inhabitants of one community, free of state’s control. These ways of combining (firms, associations, schools, clubs, syndicates, etc.) together with the place of work and family establish the organizational ground base of the daily society. In democratic theory, the civil society, as public domain of voluntary association, is essential for the democracy’s stability.”¹²

Therefore, we talk about armed forces, subordinated to the state, which is seen “as political form of organization for a human community, which, through its specialized institutions and legally established force, provides the transmission of power to different levels of society in order to coordinate public services, to assure the safety and the development of the community. The state defends and guarantees the territorial integrity and the independence of the community, whose official expression is”¹³. The way “the state defends and guarantees the territorial integrity and the independence of the community, whose official expression is” obviously represents the military. And actually, we can now correctly identify the starting point of a pertinent and objective analysis of the relations made between society and its armed forces.

The state controls its military, the nature and the intensity degree of this control have been and continue to be subjects of intense debates throughout the entire society, especially the one which is in such an extended transition as ours, subjects which are often disputed and without a doubt far from being definitely defined. The explanation is simple and it is all about the logic of the common sense: society is the sum of the individuals and groups’ interaction; it is dynamic, and the relations which it establishes with the military are a mobile perpetual, meaning the expression of a reality which is built every day.

Actually, in my opinion, the statement “relations between military and society” is not well phrased and it can induce a wrong feeling of separation which, in certain circumstances, may degenerate seriously.

The military is part of the society. It is not a separate entity, therefore it is more correct and more according to reality to refer to connections between the military and civil society or connections between the military and the political society, the military and church, etc. In this way, our efforts should focus on the concordant relations of the armed forces with the rest of the social system, and we can do this by quickening those elements which finally make possible the supreme sacrifice: devotement, loyalty, and respect of the law and of the state.

In other words, I think it is closer to the truth the pluralist vision of Charles Moskos who, according to Marian Zulean, “tried to combine the two theories (Samuel Huntington’s theory regarding the differences between the civil and military spheres of and Morris Janowitz’s theory of resemblances) by composing the ‘pluralist’ model of military civil relations. Moskos’ thesis states that the transformation of the military should be judged by its dialectic evolution, the one where the military sphere comes across both differences and resemblances of the civil one. The military is not a unitary institution but a pluralist one, where parts assimilated by the civil society coexist with parts which preserve the traditional military action and way of thinking. In this historic context, Moskos’ pluralism offered the best solution of combining the two spheres in order to accomplish the most important goals: the operational efficiency and the civil society’s observation.”¹⁴

Military culture – organizational culture, result of the Armed Forces’ interaction with the other subsystems of the social system

As mentioned before, the military is an integrant part of the social system so it is only fair to think that it shares the same cultural values as the society it protects. However, the role that military is playing is the one of defending the state, and it implies a certain type of organization, such as raising and then preserving some specific features. It is possible to witness the apparition of a phenomenon identified by certain literature as a cultural variation inside the same culture, to be more exact, we refer to what sociology calls subculture, “a pattern¹⁵ of manners, customs and values, shared only by a part of the society, and different from the general pattern of society...



Members of one subculture take part both in the ground culture and unique, different forms of behaviour; for example, using slang, the members of a subculture understand specific meanings of the words, being impossible to be understood by the outsiders. Subcultures appear when a part of the society should face some problems or unique privileges for its social position.¹⁶

So let's try to support the statement that the armed forces develop "unique, different forms of behaviour"¹⁷, but not by completely separating it from the society's ground culture.

Referring strictly to the Romanian case, what kind of society are we talking about? Are we somehow referring to the present which we like to evaluate as being democratic, to an open, modern society which has upon its armed forces a control which we also consider democratic (liberal idea which comes from the necessity of breaking the monopole of power in smaller powers, with different intensity degrees, but in balance; are we referring to an obvious instable balance because in practical daily reality there can not be a perfect balance, and if it were it would lead to blocking the functioning of the political system – a perfect balance implies the absence of movement and evolution, and the society is dynamic, in a continuous movement and changing)?

I don't think this *hic et hunc*¹⁸ approach is a fair one¹⁹, because Romania does not have a solid and long culture of democracy and the modernism today does not have a background made by centuries of economic and social progress. The Romanian state's structure comes out of feudalism with a great delay and in a forced way, practically burning the stages. Seen as a form of liberalism, progress has the general hostility of a patriarchal, traditional, peasant society, the image being one of an import product, not knowing the national realities, in other words „**the form without background**”, mentioned by Titu Maiorescu²⁰.

The Romanian military tradition does not begin with the liberalism; it is built on a tribute of the country and of the ancestors, on a tribute of the military leadership, of the savior hero of the people, a character who is closer to the Eastern tradition of the omnipresent and omni powerful father, identified in our country as the voivode. All these haven't just vanished since we became a NATO member and it would be a huge error to think that the Romanian army, now very professional and

seduced by the new approaches of security and strategy, has totally forgotten old conceptions.

On the contrary, it is rightful to notice that the transformation of the forced armies into the spirit of the occidental-liberal democracy, more exactly into the spirit of the occidental organizational culture, will not happen soon, going through what we call social changing: transformations which can be noticed in time, which create the general tendency of organizing a community.

Nevertheless, regarding the existence or non-existence of a Romanian military tradition, we notice in the military sociological research different approaches, which lead out the famous conflict between generations.

For example, Marian Zulean, representative of the young social science generation, studying in the USA, the country which presents itself as a model of democracy, has a flexible and pragmatic perception – considering that “Romania does not have a military tradition. Except from a short period of time, during the Second World War, the modern Romanian Armed Forces was always under a certain type of civil observation. During the Middle Ages, the Romanian territories were taken by the Ottoman Empire, Russians or Austro-Hungarians, so the perception the people had on the military was that of an military of conquest.”²¹ Marius Hanganu has a different point of view, he says that “the entire history of the Romanian people is a military one.”²²

I admit, to a certain point, I agree with Dr. Zulean, who is referring to the non-existing Romanian military²³ tradition and to the civil control, almost permanent inside military forces, all that because we speak about Romania as a modern country after 1859. The public opinion about the military in the medieval period of time refers to an occupation army, and this opinion is a pertinent one, as long as we speak about regular and organized army (an institution of the occupant country), meaning that kind of army (military forces) that Romanian society will know only after the institutional reform of Cuza.

But the Romanian history does not start in 1859 and it would be wrong not to consider the remarkable Romanian military phenomenon and to speak so little about the relations between the Romanian territory and the neighbouring powers. The Romanian territories were never confronted with permanent occupation but permanent



struggle and fight indeed. Even Transilvania, the Romanian tear and swing, which was under foreign occupation for a long time, had given up after long centuries of battle: the Hungarian conquest takes place on several steps, every step almost a 100 years, starting with the 9th century, when we have a resistance of the Romanian territory ruled by Gelu, Glad and Menumorut - ending almost at the beginning of 13th century.

The Romanian feudal elites, full of sins, according to those times' writers, had spoken about a flexible external policy, a survival one, **like a middle way** (the expression of Ion Conea²⁴), meaning what Sergiu Tamaş called **“an intense political life region ... where the interests and the disputes of many powers meet ”**²⁵.

Of course that we may discuss here about the Romanian armed forces, a NATO member, a modern, flexible, functional army (at least on what concerns intention).

We may discuss about the military forces that forms an institution, an organization, growing naturally into a organizational culture, but until we touch this contemporary organizational culture we needed time, time that has made the military phenomenon with less or more structure, had planted and conserved cultural elements preserved in social memory (it's true that there is a world of traditional songs, military ones, that refers directly to regular, modern military — for example, in Teleorman region, there are many songs about the Independence War 1877-1878, but we don't have to ignore the popular creations that speak about the bravery of the Romanian rulers, about the fact that Romanian people had left and joined the military, about the old woman, Vrâncioia, that offered all her seven sons to the ruler Stephen the Great: “Here, I have my stout and beautiful seven sons. I offer you all them, to help you on the salvation of the country”). I myself stand for the facts that “the whole Romanian history is a military one”.

I wanted to make these comments because when we try to track down sub-culture military elements on the society cultural ensemble, we have to give importance to the principle of continuity and constant reporting to history: the cultures never conceive over the night, by nothing, and “the world we live in did not begin yesterday ...”²⁶.

And, without any doubt, this world is an organizational one that has to respond to an unprecedented challenge: the huge cultural variety

of individuals, classes, communities, societies.²⁷

What is the organization and what do we understand by organizational culture? Lisette Coandă says that the organization is one of the fundamental elements of social structure, the member of the society forming: “the social classes, the organizations and the institutions, on the process of social interaction”²⁸.

The Explanatory Dictionary of Romanian Language explains that, the organization is a “people association with common beliefs or concerns, affixed by a regulation or statute, with the object of depositing an organized activity”²⁹.

Regarding organizational culture, this concept “refers to all that means collective standards of thinking, standings, values, assurance, rules and customs that exists within an organization. The organizational culture conceives on account of repeated interaction between organization members, getting together the beliefs and the values, although there are powerful shaping factors that custom all, for example, the kind of ruling and the way of taking calls, the starch level, the organization's structure, the policies and the know-how, and all those systems that give quality and support to a certain type of work and to a certain type of behaviour.”³⁰

Marian Zulean, in his study about civil-military relationships, **Militarul și societatea – relațiile civil-militare la începutul mileniului al III-lea** (The soldier and the society- the civil-military relationships at the beginning of the IIIrd millennium) is operating an analysis of military culture, starting with the vision of Amitai Etzioni about the contemporary organizational phenomenon: “the organizations are cultural systems headed for objects. The object of an organization is the key of concords between structure and specific culture”³¹.

Therefore, once we detected the object, the military structure mission, we can understand and operate upon the concept of military organization culture. So, once the military organizations are “specialized on using collective threat and violence”³², we may say that “the war causes central conviction, the values and the symbolical complex structure that cause military culture”³³. Following this logic, the military organizations claim an enhanced level of coordination. That is why “the military culture of the military is ... based on a leadership strictly structural up-down,



POINT OF VIEWS

like a command chain organized according to centralization principle.”³⁴

Here we track another problem: this war is possible never to come.

However, the soldier is always prepared on time of peace for the possibility of a confrontation, but this preparation “is based on simulation, hypothetical presumptions and past operations”³⁵. In other words, the soldier operates with potential situations and facts which he does not live by fact, but may cause behaviour mutilation clearly on the quality of social developing concerns: “the low level of feed-back from the social environment may lead the majority of military cultures to a strong self-orientation. This leads to a tendency of observance behaviour. From functional perspective, the observance serves ‘at the guiding of the individual behaviour’ and ‘to give an image in front of the tough reality of death and destruction that sometimes threatens to be overwhelming”³⁶.

Therefore, we discover here a behaviour shaping activity by observance, meaning by stereotypical standings, but full of shrewd significance, intended to develop the soldier’s capacity to face the possible challenges (the war problem that may never come), based on the canon that courage can be learned.

All of them, corroborated with the fact that the military organization is a closed one, the soldiers are living on barracks and guard houses, isolated from the rest of the society, perceived as a civil one, is bringing a certain community placement on values’ scale, a placement that the soldier hunk on his favour: “For the functional needs, the community is more appreciated than the individual, the collectivity has a clear priority. According to the military culture, the individual is an instrument in favour of the group and is expected for the soldier to sacrifice his freedom and, if imminent, his life, for a collective aim that can be possible not to join.”³⁷

Obviously, in order to probe such a behaviour, the soldier may need a whole area of peculiarities like: discipline, bleep capacity, high morale, accepting self conditions by concordant professional identity and growing a favourable theory of the community and solidarity, therefore, against selfhood, etc.

It is very interesting to watch the work schema — regarding the investigation of civil-military concerns and tracking down the cultural differences between military and society, starting from a framing of the society based on the formula

segment-whole, system/subsystems (formula, that I personally consider as being a fair one) — advanced by Nicolae Dolghin, Petre Duțu and Alexandra Sarcinschi ³⁸ in Table 1.

At the beginning of my demarche I stated the fact that research on civil-military concerns is a pioneer effort, but necessary, because Romania is living today a specified reality, defined by its new quality, member of Euro-Atlantic structure.

This context is not an easy one, on the contrary, it has all the peculiarities of a transition, from positive to unknown throwing, bringing major changes regarding the quality and the quantity of the customs that military forces is developing with the society, added differences but also resemblance: “Today, when Romania has become a NATO member and has been evaluated on control democratic civil valuation rules, it is interesting to find out that there is a difference between military culture and parenthood society. As the technical criteria for joining NATO require a professional military, is least accepted that the military professional process is leading to a new militarized culture, growing differences between Romanian society.”³⁹

Regarding this civil-military issue, there are some sociologic methods, as questionnaire or interview, but those are few and the coverage area is insufficient.

Unfortunately, we can’t say that it has been a sociology research effort on national level and it is obviously that only a span inquest can bring objective assessments. But even only referring to present information, we can detach some interesting ideas.

We have, in that direction, the paper of Marian Zulean, **Diferențe culturale dintre armată și societate** (Cultural differences between society and military), the analysis of an investigation that took place on 2005, in the academic environment, with the declared purpose of comparing civil students accounts, classes of economics and political, with the accounts of military students, starting from the facts that actual political elite had graduated those kind of studies: “In a recent study prepared by the Centre for Analysis and Political Studies (CASP) on the careers of the post-communist leaders, it raised the fact that primary specializations of members of Parliament after 1990 are: engineers (40%), specialists in social sciences, economists and lawyers.”⁴⁰



POINT OF VIEWS

The result of this investigation is the identification of some cultural elements, common embraced both by civil and military students like: fundamental values of society (the state governed by laws, respecting the laws, the human and citizen's rights) and also those ones regarding the community's religious convictions.

Also, there had been pointed out common points of view regarding the role of military forces in the context of contemporary risks and threats on international organizational phenomenon or on the way women are integrated within the military.

Regarding the differences, these had been identified, mainly regarding the values, like patriotism, the role of discipline on the education of young generation, the actual orientation of external policy and the security of Romanian state, the vision on military profession on military service obligation, etc.

The conclusion of this investigation, according to Dr. Zulean, it was that even these differences had been noticed, although they are not so deep in order to justify the legitimate fear, otherwise we could confront with "a society military tendency.

On the contrary, certain experts consider that the civil democratic control institutions, the measures for the army's professionalization, in order to make it more compatible with NATO, can be a risk of 'civilizing' the army."⁴¹

Furthermore, Dr. Zulean fairly asserts that the investigation is not representative, but I cannot agree with him when he states that national sociological research should "include both officers and actual elite by sample ..."⁴², because the society is not diminished only to officers' corps and elites (no matter the nature: intellectual, political, economical, and financial). It's true that when we speak about military culture, we give emphasis to the role of officers' corps, as opinion training, being also reasonable to consider that we can track down an officers' culture within military one. Similarly, we cannot mistrust the fact that a society's voice is the elites' voice and when elites are sleeping, the society is sleeping too.

The social system, globally, works through permanent harmonization of all subsystems and to have a closer picture to the truth concerning a issue or another problem (our case, the cultural differences between society and military) a professional investigation is necessary that include military elites and also the troupe (finally, it's a confrontation with the supreme sacrifice on operations' fields), political elites, intellectual ones etc. , but also the civilians structured on age, sex, socio-professional criteria, etc. Only such sociological demarche can be representative and only then we can draw pertinent conclusions regarding civil-military concerns, such as cultural semblances and differences.

SOCIETY	MILITARY
Hypothetical, abstract, part and parcel being only based on bureaucratic tool and static observation.	Actual scheme, high degree of institution.
A non-structured whole, institutions' aggregation, mostly intermission and groups formally organised or not.	An established institution based on laws. It's a system of interrelated roles, whose representatives have a behaviour governed by severe obligations. Obviously structured by vertical.
It's not about the selection of society's members (compulsively speaking about the social marginalisation, but this does not mean that those chaps are expelled from the society, they are only filled out on a special category).	The recruitment of its members is based on certain principles, from that societies' members, as the access to this institution is checked.

Table 1



Conclusions

Undoubtedly, counting our military spadework, we cannot dispose of a solid investigation based of civil-military concerns that can make possible the formulation of some permanent assessments, adding the fact that society is reacting quite confused to the past or current military transformations: we have an ongoing process, and the attitude is an expectative one, the reactions are often incoherent. Even so, “the nature and the content of these concerns are being asked to be known by responsible society factors for desirable and effective intervention when necessary for minimizing or maximizing unwanted consequences.”⁴³

Regarding shaping the contemporary military, in the complex globalization context, that brings new placements on values’ scale, yesterday thought as untouchable (for example, the concept of national state or not interfering on internal affairs, the so often mentioned at Helsinki, in the 1970s⁴⁴, etc.), I will make an appeal to a serviceman’s appreciation, member of “the officers’ corps and an opinion maker”, Major General Professor Nicolae Uscoi, PhD, “generally speaking, the reforms that pass over the modern militaries have many common characteristics, but also indubitable specific aspects. The modern military is reflecting the national people’s culture and the society’s technological level. Also, each military has a unique relation, one not to be confounded with civil society and defending the nation. This situation explains the differences, including the manner of producing transformations on peacetime.”⁴⁵

And here we find the correct starting point for the current and future studies regarding this complex issue: the society is defended/ the military is defending.

REFERENCES:

ACADEMIA ROMÂNĂ, INSTITUTUL DE LINGVISTICĂ „IORGU IORDAN”, **Dicționarul Explicativ al Limbii Române**, Editura Univers Enciclopedic, București, 1998.

BALL, Terence, DAGGER, Richard, **Ideologii politice și idealul democratic**, Editura Polirom, Iași, 2000.

COANDĂ, Lisette, **Sociologie Generală – note de curs**, Editura Universității Creștine „Dimitrie Cantemir”, București, 2005.

DOLGHIN, Nicolae, DUȚU, Petre, SARCINSCHI, Alexandra, **Raporturile dintre armata României și societatea civilă**, Editura Universității Naționale de Apărare „Carol I” București, 2005.

GIDDENS, Anthony, **Sociologie**, Editura BIC ALL, București, 2000.

MUREȘAN, Mircea, MOȘTOFLEI, Constantin, DOLGHIN, Nicolae, DUȚU, Petre, **Raporturile dintre armată și societate în contextul integrării României în NATO și aderării la Uniunea Europeană**, Editura Universității Naționale de Apărare „Carol I”, București, 2007.

RADU, Alexandru, **Sisteme politice contemporane – curs universitar**, Editura Universității Creștine „Dimitrie Cantemir”, București, 2006.

ro.wikipedia.org

TAMAȘ, Sergiu, **Geopolitica – o abordare prospectivă**, Editura Noua Alternativă, București, 1995.

TOHĂNEANU, Cecilia, **Sociologie politică – curs universitar**, Editura Pro Universitaria, București, 2006.

USCOI, Nicolae, **Repere teoretice ale transformării instituției militare** (The paper has benefited support from MEC-CNCSIS, by Contract no. 32950/22.06.2004, code CNCSIS 812).

VLĂSCLEANU, Mihaela, **Organizații și comportament organizațional**, Iași, Editura Polirom, 2003.

www.elfconsulting.ro

ZULEAN, Marian, **Militarul și societatea – relațiile civil-militare la începutul mileniului al III-lea**, Editura Militară, București, 2008.

NOTES:

¹ Sir Karl Raimund Popper (1902-1994), English philosopher originating from Austria, considered to be one of the greatest philosophers of the twentieth century’s science, founder of the critical rationalism against the historic determinism, objected to each form of skepticism, conventionalism and relativism both in science and human activity in generally, stood up for the idea of an open society, was an implacable opponent for any form of totalitarianism, source: ro.wikipedia.org.

² Francis Fukuyama, American sociologist and political writer, **The End of History and the Last Man** (1991), is the book which brought him international notoriety, source: ro.wikipedia.org.



³ Dr. Marian Zulean's study, **Diferențe culturale dintre armată și societate**, published in 2005, edited by National Defence University Carol I", Bucharest.

⁴ Anthony GIDDENS, **Sociologie**, Editura BIC ALL, București, 2000, p. 26.

⁵ George Simmel (1858-1918), German sociologist and philosopher, was noticed after his works on urban sociology, social conflict and established relations between some social units – individuals, groups, source: ro.wikipedia.org.

⁶ Lisette COANDĂ, **Sociologie Generală - note de curs**, Editura Universității Creștine „Dimitrie Cantemir”, București, 2005, p. 16.

⁷ Comment on Auguste Comte in Anthony GIDDENS, **op. cit.**, p. 16.

⁸ Ibidem.

⁹ Ibidem.

¹⁰ Alexandru RADU, **Sisteme politice contemporane – curs universitar**, Editura Universității Creștine „Dimitrie Cantemir”, București, 2006, p. 6.

¹¹ Nicolae DOLGHIN, Petre DUȚU, Alexandra SARCINSCHI, **Raporturile dintre armata României și societatea civilă**, Editura Universității Naționale de Apărare „Carol I” București, 2005, p.5.

¹² Cecilia TOHĂNEANU, **Sociologie Politică – curs universitar**, Editura Pro Universitaria, București, 2006, p. 65.

¹³ Nicolae DOLGHIN, Petre DUȚU, Alexandra SARCINSCHI, **op. cit.**, p. 3.

¹⁴ Comment on Charles Moskos in Marian ZULEAN, **Militarul și societatea – relațiile civil-militare la începutul mileniului al III-lea**, Editura Militară, București, 2008, p. 11.

¹⁵ Pattern – model, type; cultural patterns - control behaviour patterns that the social environment, aware or not, impose upon its members ; the classification of this patterns represents a cultural typology, definition in Lisette COANDĂ, **op., cit.**, p. 73.

¹⁶ Lisette COANDĂ, **op., cit.**, p. 51.

¹⁷ Ibidem.

¹⁸ Hic et hunc – here and now, lat.

¹⁹ Of course, I share a great admiration to the broad values myself, where the pragmatism has its duly place. But carrying on quick intercedes, with the asserted aim of establish civil democratic control upon the army, transforming the military forces in correspondence with the war new vision, that's no longer a classic one, behave a major risk: induce the idea of a compulsive action and certainly rises a legitimated question: on what scale those processes are being compatible with the national culture?

²⁰ Titu Liviu Maiorescu (1840-1917), academician, lawyer, politician, writer.

²¹ Marian ZULEAN, **op. cit.**, p. 81.

²² Statement made during “Military security and defensive concepts; planning the defence” course within

the Master courses on “Security and defensive studies”, “Dimitrie Cantemir” University.

²³ Militarism - subordination policy of state activity ,social life, potential military interests and preparation for the war, keeping the relations of domination by force, internal and international-fr. Militarisme - **Dicționarul Explicativ al Limbii Române**, Academia Română, Institutul de Lingvistică „Iorgu Iordan”, Editura Univers Enciclopedic, București, 1998, p. 634.

²⁴ Ion Conea (1902-1974), Romanian geographer and politician, reader, important specialist on geographic toponymy and history. He conducted the monograph search of Clopotiva village (Hunedoara region), fully edited on 1940 as **Clopotiva, un sat din Hațeg – Monografie sociologică**. He was a collaborator of Geopolitică și geoistorie magazine, source: ro.wikipedia.org

²⁵ Sergiu TAMAȘ, **Geopolitica – o abordare prospectivă**, Editura Noua Alternativă, București, 1995, p. 55.

²⁶ Terence BALL, Richard DAGGER, **Ideologii politice și idealul democratic**, Editura Polirom, Iași, 2000, p.18.

²⁷ Mihaela VLĂSCEANU, **Organizații și comportament organizațional**, Iași, Editura Polirom, 2003, p. 391.

²⁸ Lisette COANDĂ, **op. cit.**, p. 32.

²⁹ **Dicționarul Explicativ al Limbii Române**, Academia Română, Institutul de Lingvistică „Iorgu Iordan”, Editura Univers Enciclopedic, București, 1998, p. 726.

³⁰ Source: <http://www.elfconsulting.php?nrdef=14>

³¹ A comment on Amitai Etzioni in Marian ZULEAN, **Militarul și societatea – relațiile civil-militare la începutul mileniului al III-lea**, Editura Militară, București, 2008, p. 57.

³² A comment on James Burk, Ibidem.

³³ Ibidem.

³⁴ A comment on Maurice Feld, Ibidem.

³⁵ Marian ZULEAN, **Diferențe culturale dintre armată și societate**, Editura Universității Naționale de Apărare, București, 2005, p. 6.

³⁶ Ibidem.

³⁷ Ibidem.

³⁸ Nicolae DOLGHIN, Petre DUȚU, Alexandra SARCINSCHI, **op. cit.**, p. 16.

³⁹ Marian ZULEAN, Ibidem. p. 16.

⁴⁰ Idem, p. 17.

⁴¹ Idem, pp.31-32.

⁴² Ibidem.

⁴³ Mircea MUREȘAN, Constantin MOȘTOFLEI, Nicolae DOLGHIN, Petre DUȚU, **Raporturile dintre armată și societate în contextul integrării României în NATO și aderării la Uniunea Europeană**, Editura Universității Naționale de Apărare „Carol I”, București, 2007 p. 92.



POINT OF VIEWS

⁴⁴ The principle of “not interfering on domestic affairs” – “The participating states will not interfere, directly or not, individual or collective, on domestic or foreign affairs that represent another state national competency, no matter the mutual reports”, the Final

Act of the Conference on Security and Co-operation in Europe, Helsinki, August, 1975.

⁴⁵ Gl. mr.prof.univ.dr. Nicolae USCOI, **Repere teoretice ale transformării instituției militare**, p. 1. The paper has got support from MEC-CNCSIS, contract no. 32950/22.06. 2004 (code CNCSIS 812).

Grațiela VLĂDĂIANU (gratiela.ploesteanu@yahoo.com) graduated the Political Science Faculty from the Christian University “Dimitrie Cantemir” and attends a master on “Security and Defence Studies”. Her expertise area includes: contemporary political systems, political doctrines, bipolar international security.



THE NEED FOR NATO'S TRANSFORMATION. GENERATING FACTORS

Aurelian RAȚIU

The following article presents some aspects regarding NATO's transformation and factors that initiated or maintained this process. The analysis has focused upon NATO's transformation from the conceptual, structural and operational point of view.

Social changes, military transformation, asymmetrical threats, Capability Commitment, modular force structure, Effects Based Approach to Operations are concepts which the Romanian Armed Forces have to consider thoroughly and also developing other new ones, for growing firm our country's profile within the Alliance.

Keywords: NATO, risk factors.

1. International context and risk factors

The roots of the changes which have transformed the political map of Europe can be traced to a number of developments during the 1960s and 1970s (the adoption by the Alliance of the Harmel¹ doctrine, the introduction by the Government of the Federal Republic of Germany of "Ostpolitik" (Eastern Policy), designed to bring about a more positive relationship with Eastern European countries and the Soviet Union, or the adoption of the CSCE² Helsinki Final Act), and during 1989 this series of events, with significance for the entire European continent and for international relations, as a whole, has continued with the collapse of state institutions (the disintegration of the USSR, the reunification of Germany) and defence (the Warsaw Pact), which seemed indestructible.

Transformations that appeared to have been an early establishment of a fair political and "eternal peace" through the mocking of the concept of war have rather created instability and even chaos, new challenges that people, both individually and collectively, did not know to meet and face. At the same time, various conflicts (military or otherwise)

broke, with greater virulence, also on other details and new features, leading international organizations to support changes and adaptations in order to avoid and resolve disputes and even armed conflicts that could occur by peaceful means. One of these organizations is the North Atlantic Treaty Organization.

Thus started the construction of a new security order based on other criteria. If during the Cold War NATO's main mission was to protect the members against the Soviet threat, the end of the war adds a very important function that is usually undertaken by security organizations, and that promotes the *integration* and *cooperation* of states.

NATO's transformation is not a new thing, and it is hard to imagine a time that the Alliance has not been in the process of reinventing itself.

However, paradoxically, this process has not been a classical transformation from top to bottom: the institutional and structural pattern of NATO has not changed fundamentally with the disappearance of the Soviet Union, as it is clearly *exceeded* by the NATO *enlargement*, and the increasing number of *tasks* and *activities*³.

The danger of the Soviet invasion in 1991 being obsolete, questions about the future of the Alliance and its imminent disintegration arose, as well as questions about its role as a security organization on one hand, but also how the security issues of the Member States of the former Warsaw Pact can be resolved, on the other.

Debates have been centred not on the issue of abolition or continuing the existence of NATO, but on what should be done from now on, considering the new strategic environment maintained dangers and threats to the security of Europe.

The challenges and risks that NATO is facing are different from those in the past. The threat of an attack or a massive surprise, simultaneously on all of NATO's European fronts, has been removed and there are therefore no longer the central



concern of the Alliance strategy⁴, but the risks to the European security persisted and were multiple and multidirectional, making them difficult to assess or predict, as the instability that could come from economic difficulties, social and political rights, including ethnic rivalries and territorial disputes, that some Central and Eastern Europe states face.

Therefore, the existence of the North Atlantic Alliance and its transformation had to take into account the international context in which security interests could be harmed by the nature of the risks of proliferation of weapons of mass destruction, the emergence of intra and interstate conflicts arising from the disruption of access to vital resources, separatism, international terrorism and crises of various types that can grow quickly and require a response on the measure.

At the end of all bipolar rivalries, the confrontation of the Cold War has been replaced by an extremely fluid and complex landscape of security. The North-Atlantic Alliance was static, both defensive and reactive, but gradually it has changed the perception of security and its role, or rather the Armed Forces', from maintaining the necessary defensive capacity against a possible aggression to participating in peace, developing relationships with other security organizations and countries deemed by opponents and then subsequently accepting new members. The events of the '90s (conflicts in the Balkans, the enlargement process) have proved that NATO is a flexible organization that adapts macroeconomic environment of security. That was the beginning of the "globalization of NATO"⁵ in response to globalization risks in a world where insecurity is no longer defined in geographical territorial parameters.

The security environment is characterized by a high degree of instability and unpredictability, the manifestation of new risks and threats, especially asymmetric ones, the redefinition of relations between major powers and increased freedom of action of regional actors (state and non-state).

Today's security threats have two qualities that make efficient application of pre-designed tools difficult. Firstly, non-traditional threats stem from societal developments rather than from governmental decisions, thereby forcing strategists to reconsider traditional instruments such as military intervention and deterrence. Secondly, uncertainty is a defining feature of security policy today, since

the motivation, intentions and capabilities of non-state adversaries are often unknown⁶.

The emergence of such risks and threats required a metamorphosis and a restructuring of the Alliance, its mechanisms for crisis management were adapted to the new context, more vulnerable, more uncertain. Under these uncertain circumstances, NATO has had to adapt its commandments and military forces to operate effectively and to be used quickly to wherever they were needed.

At the same time, allies have also sought to reduce levels of uncertainty by helping build political stability and transparency in crisis regions. This dual approach *has guided the adaptation process* that, albeit hesitantly, NATO has undergone since the end of the Cold War, in which it is possible to identify *three elements*⁷, each with its own motives and driving forces.

The first element has been the construction of security partnerships aimed at extending the region of stability within Europe. In response to the vacuum created by the demise of the Warsaw Pact, NATO offered cooperative structures to tie in former adversaries, including eventually a mechanism for joining the Alliance, and to integrate partner armies into crisis-management operations in Europe.

The second element relates to the growing willingness of NATO to use force in crisis management and stabilisation – first in the Balkans, now in Central Asia.

The third element grew out of the restructuring of Cold War forces during the 1990s and has evolved into today's ambitious force-transformation programme. The military requirements of the Alliance's new operations put the original reforms under strain.

All the above are the answer to the question "why" it was necessary to start the process of transforming NATO. It was necessary for the Alliance to be able to cope with new risks and challenges in the security environment, to act in increased and diversified missions and operations, and to be ready to be called upon to respond in a geographic area much over the traditional boundaries.

2. Theories addressing the change

It is an axiomatic truth that the world is continuously changing, the only constant being change itself.



According to the dictionary⁸, change and transformation are defined by one another: Change – to modify, to change, replace, and transformation - of (the) metamorphosis, and (is) pretending, and (is) changed, becoming, change, and (tell) change appearance, give or take on another aspect, another shape.

According to the specialized literature, we can identify the source of change or transformation in the life of an organization.

Change is all the activities, which are based on knowledge, innovation, design, planning, processing, acquiring, development and evaluation of all activities that are involved.

The US Department of Defense defines transformation⁹ as “*a process that shapes the changing nature of military competition and cooperation through new combinations of concepts, capabilities, people and organisations that exploit our nation’s advantages and protect against our asymmetric vulnerabilities to sustain our strategic position, which helps underpin peace and stability in the world*”.

The changes are generated by the mega-tendencies from all of the systems or subsystems. These are large, obvious for large periods and present in all areas of activity.

Change represents a group of radical transformations to a sustainable and significant process, which is produced to face the various situations and in particular to the crisis.

The process of becoming and NATO’s transformation can be explained from a theoretical perspective using the main theories that represent the processes of organizational change.

*The Life-cycle theory*¹⁰ is the theory used in literature to explain the development and organizational change. The main features of this theory are:

a) *the change is imminent*;

b) *events in the [International Security] environment determine change* - 1989 may be considered the year that triggered the principle of domino, the major changes on political and social Europe, forcing the radical reconfiguration of the military and later, the political -military alliance;

c) *change is the result of taking a series of phases* – NATO’s transformation can be split into two major phases: the first years of the last century, when NATO is distinguished by the search for a new identity and launching partnerships, and

1995, when the Alliance focused not only on the issue of enlargement, but also involved militarily in activities in Bosnia and Kosovo. The second phase deals with more assurance on expansion, but also on military engagements in remote areas that are contrary to the consecrated famous article 5 of the North Treaty Atlantic;

d) *change is cumulative*, in the sense that the experience gained in intermediate stages is used in the next stage – NATO has expanded the sphere of interest, enriching its agenda with issues on which it now operates, and also adapts to missions done by redefining its objectives, changing the geographical area of the allied territory, and by designing stability beyond the Euro-Atlantic region itself, operations “out of area” to its current ambition to act where needed;

e) *change is conjunctive*, because the phases result logical from one to the other, evolving on a preset trajectory – therefore, it went through a complex process of transformation (which continues), determining the risks that must be faced and the modification is reflected in its structures (number of members, organizational chart) and the type of response that it must generate.

According to organizational theories, there are three types of behaviours to ensure the survival of an organization as an important factor in the international environment: *adapting to change, the organization needs support and resistance to change*. During its existence, NATO has applied for all three types of behaviour above mentioned, a decisive role in taking the process of adapting it.

The need for transformation can be in any field, but especially in an environment as choppy as the security one.

The impetus to transform may vary. In some cases, transformation is stimulated by rapid deterioration in an organisation’s competitive position resulting from unforeseen and unanticipated changes to the competitive environment, or by hitherto unknown rates of change. In other cases, transformation is opportunity driven, resulting from the desire to create or enhance competitive advantage.

The transformation may require four stages:

• *diagnose the situation and detailing with critical issues* – NATO’s transformation involved identifying those priorities and means of action to maintain relevant in the new context of international security. Challenges to the security area have



intensified as risks have begun to see a widening relocation;

- *design and planning action transformation* – developing the Strategic Concept in 1991 and its revision in 1999, the adoption of new SCENAR planning, significant reforms of the structure of command, they are all directions of transformation that NATO undertook since the end of the Cold War, with the aim of developing relevant capabilities for defence. Also, the Prague summit marked a new stage in this process, resulting in the development of initiatives (Its Commitments, the NATO Response Force) involving the review of the planning process for the enactment of defence, following the effective links between strategic objectives and capacity requirements;

- *implementation of the changes through the implementation of the entire system of transformation* – it has gone from strictly military operations for crisis management, conflict prevention, peace-support operations, response to disasters, civil emergencies, humanitarian assistance, etc., partnerships with NATO were developed in areas of interest (the former Soviet space or the Mediterranean area);

- *the transformation's monitoring and evaluation* – the Strategic Concept review, analyzed in every summit or meeting of the North Atlantic security environment, risks/threats and implications for the Alliance, the objectives and functions of security requirements on current military operations, the directions for action in priority areas.

Given that, policy changes, geopolitical and environmental security have imposed the transformation of the North Atlantic Alliance into an organization that ensures collective security and regional stability -even global -, NATO is obliged to adapt **in concept, and operate with the new realities**, so that it can respond effectively and opportunity increasingly complex challenges so diversified in the current security environment.

3. The sub-processes of NATO's transformation

In the field of security, there are two ways by which an organization may define the meaning and the content of transformation: *a comparison with other organizations* and *internal assessment*. NATO, at that time, had no other competing organization to compare with, and therefore

appeared as an internal need to security to meet effectively the risks and threats in the complex strategic environment.

The starting point in NATO's transformation was the *London Declaration On A Transformed North Atlantic Alliance*, 1990, which represented a shift from a defensive and reactive approach to security in a more proactive and focused on expanding security and stability. However, the transformation process has been triggered by the **Strategic Concept**, adopted at the meeting to peak in 1991, in Rome. The concept combined the maintenance of collective defence capabilities with a substantial reduction in the size of forces, political and military aspects of NATO doctrine, the increased use of multinational groups, creating a Rapid Reaction Corp, and adaptation procedures for planning defence. The meeting in Rome (Nov. 1991) resulted in three main documents: "*The Alliance's Strategic Concept*", Declaration on the "*Development in the Soviet Union*" and "*Rome Declaration on Peace and Cooperation*."

Since 1992, NATO has assumed the role of promoter of security in any part of the world and the backdrop of crisis in the former Yugoslavia and in other regions, attention was increasingly drawn to NATO's role in resolving crises and peacekeeping and in particular to support the UN peacekeeping activities.

Following the Summit in London and proposed Declaration of Heads of State and Government to facilitate cooperation in the Euro-Atlantic space and in a very short period (December 1991) being taking *North Atlantic Cooperation Council* (NACC), which, in 1997, has been replaced by the *Euro-Atlantic Partnership Council* (EAPC), a forum to bring together the new NATO and partner countries to discuss issues of common interest.

This state of affairs has changed in 1994, due to the launch of the Partnership for Peace (PfP), an important practical bilateral cooperation between NATO and partner countries, which represented a significant qualitative leap in the process of cooperation.

These processes and initiatives of cooperation continued to develop the reminding creation of the Mediterranean Dialogue in 1995 and the formalization of bilateral relations between NATO and Russia that NATO and Ukraine in 1997. During the Summits in Prague, Istanbul, Riga and Bucharest, there have been undertaken



efforts on strengthening cooperation between NATO and partners, and on the effectiveness of the partnership to address the security challenges of the 21st century.

On 24 April 1999, celebrating the 50th anniversary, the Alliance adopted at the *Washington Summit*, a *new Alliance's Strategic Concept*. This is considered to be second in the hierarchy of policy documents of the Alliance, after North Atlantic Treaty.

The updated Strategic Concept provides overall guidance for the development of detailed policies and military plans. It describes the *Purpose and Tasks of the Alliance* and examines its *Strategic Perspectives* in the light of the evolving strategic environment and security challenges and risks. The Concept sets out the *Alliance's Approach to Security in the 21st Century*, reaffirming the importance of the transatlantic link and of maintaining the Alliance's military capabilities.¹¹

One of the main issues addressed in the updated concept is redefining the fundamental security tasks of the Alliance. Strategic Concept of 1999 added two missions turned into fundamental: one *related with crisis management*, including *conflict prevention* and *response operations in crises*, and another, to *strengthen dialogue and cooperation* with other nations in the Euro-Atlantic region.

Perhaps the most interesting dynamic in the concepts of the initiative had a *Defence Capabilities Initiative* – DCI – launched also during the high-level meeting in Washington, in April 1999, following the identification of new security challenges of the 21st century, to set new threats' picture so it is ready to resolve various crises, while at the same time the ability to cope with its responsibilities core of the defence of its members. Defence Capacity Initiative was launched to ensure that NATO is ready for any case.

If more was needed, terrorist attacks in New York, Madrid and London have demonstrated once again, that unconventional threats to global security are multi-directional in character, difficult to forecast, analyzed and fought.

Taking into account these events and trends, the NATO Summit in Prague in November 2002 took the important decision to engage in a process of profound transformation of the Alliance. This included enlarging NATO, reshaping the structure of military command and structure of forces to which it added new measures designed to optimize

the effectiveness and efficiency of the Alliance: *Prague Capability Commitment* – PCC, a *new NATO Force Structure* and *creation of the NATO Response Force*.

On this road opened by Prague Summit, the transformation mechanisms of cooperation within the Alliance in Istanbul received a new development.

The *Istanbul Summit*, held on 28-29 June 2004, focused on the problem of designing security and stability, reshaping the package of political decisions in Prague, reaffirming the growing global role of NATO and pursue three major pillars: the *expansion of operations*, *development capabilities* and *strengthening the partnership*. It was an event of reference for the evolution of the North-Atlantic Alliance, offering a new dynamism and partnerships NATO missions in the Balkans to Afghanistan and the Black Sea to the Mediterranean and the Middle East.

Allied leaders participating in Istanbul have given the North Atlantic Council tasks to prepare a general policy directive in order to support the *Strategic Concept*, with regard to all aspects of capabilities, planning and information Alliance, adopted at the *Summit in Riga* in 2006. *Comprehensive Political Guidance* sought to increase the importance of political decisions at the national commitment to improve the capabilities and contribute, while harmonizing the different areas involved in the design, to the development and placement capabilities in the field.

NATO's enlargement, the protection against ballistic missiles in Europe, the commitment in Afghanistan and the continuing fight against terrorism are the main topics discussed within the *NATO Summit in Bucharest* (2-4 April 2008), and the leaders of Member States have expressed their support for the efforts for the military transformation of the Alliance and for maintaining its effectiveness and new types of missions and tasks of security.

4. Transforming NATO's political-military structures

The complexity and dynamic international security environment have recorded a rapid pace of development of the North Atlantic Alliance. Thus, it went through a complex process of transformation, determined by the risks which must face and which



were reflected in modifying its structure (number of members, organizational way) and the type of response that should it generate.

In September 1994, the Military Committee proposed a study to examine the integrated military structure of NATO and to submit proposals to change the structure of forces, command structure and common infrastructure of the Alliance. Since before the completion of the study, foreign ministers from NATO countries have adopted a number of main lines of action in the meeting in *Berlin in June 1996*, defining the purpose of Alliance missions, for which performance was necessary to adapt the new structure of command.

Also in 1996, there was established Policy Coordination Group (PCG), the main consultative body of the North Atlantic Council on politico-military issues providing advice and directions for improving operations management, development concept *Combined Joint Task Forces – CJTF* and also in support of the Military Committee approved the establishment of a new cell Capabilities Coordination Cell (CCC), in order to ensure the Staff needed to take decisions and to forward them to commandments strategic NATO and to develop procedures for planning operations¹².

Another illustration of how the allied military forces and command structures are adapted to new circumstances is the military concept known as the Combined Joint Task Forces (CJTF). Therefore, in 1996, the Combined Joint Planning Staff (CJPS) is established for planning the operations of the Task Forces and commandments to decide who will be involved effectively in their leadership. Many of the CJTF concept features have been implemented in the context of NATO operations in the Balkans.

The transformation of NATO structures supported also downsizing personnel in the commandment and also the significant reduction of conventional forces¹³.

Also, at Washington, NATO launched the “*European Security and Defence Identity*” meant to help the military forces of the Alliance to become more mobile, more interoperable, more sustainable and more efficient.

In a similar way, the Alliance introduced changes in the structure of the integrated military command which is reflecting the security environment transformed. These changes will allow NATO to do the operations in an efficient way. Considering the events and trends after September 2001, at the

NATO Summit from Prague, of November 2002, the important decision was taken to start a deeply process of transformation of the Alliance, which included the *remodelling of the military command structure* and the *structure of forces*, through which the insufficiency of capacities is addressed by the member states on the basis of commitments and initiatives of individual cooperation.

The Prague commitments materialized in three separate initiatives:

- a wider set of commitments in capabilities - “Prague Capability Commitment” - which ensure the investment framework of member states into a range of new capabilities including C4ISR (Command, Control, Communication, Computers, Intelligence, Surveillance and Reconnaissance), appeared against of missiles at the theatre stage, information superiority, mobility, support and logistics;

- the commitment to create, until 2006, a NATO Response Force – NRF - composed of 20.000 people – with land, air force and naval components which works on rotation principle, every six months, deployable in five days after NAC decision and which can be sustained for 30 days of high-intensity fight;

- the NATO’s restructured military command, including the new Allied Command Transformation – ACT -, to act as the focus and motivating agent and to stimulate relevant, coherent, integrated and operational military reform between the members of Alliance.

The Prague Capability Commitment is distinguishing by the DCI by the fact that the allies assumed individual the enrichment firm political commitments of individual capabilities in accordance with the established program and following the gap reduction between the USA and European allies in technology domain and military capabilities, especially considering the fact of force projection for execution of expeditionary missions.

The NATO Response Force (NRF) is the concretization key element of efforts’ transformation that will ensure a high-technology force, agile, rapidly deployable, interoperable and sustainable for whatever duration and tempo of operation. This would include elements of land, naval and air force and which would be ready to move quickly everywhere is necessary, according to the decision of North-Atlantic Council. NRF is now the focal point of forces’ transformation serving as a testing



land for new technologies, doctrine and procedures.

Another important decision of Prague summit was to change the command structure of NATO for providing a “*NATO’s military command structure report providing the outline of a leaner, more efficient*”, which can be easily deployed, “*for meeting the operational requirements for the full range of Alliance missions*”¹⁴.

If at the political-military level, from the organizational perspective, there are not large differences over the structure known in the military at all levels changes are decisive.

At strategic level, it has two commands: one operational, Allied Command Operations (ACO), responsible for all NATO military operations, and another one for transformation, Allied Command Transformation (ACT) which will ensure the continuation of changing military capabilities and promote interoperability between forces.

Operational level has a strong character functional (and not regional) and commands have been noticeably reduced from five to three which are subordinated to Allied Command Operations: *Joint Force Command* – JFC Headquarters, in Brunssum (Netherlands), *Joint Force Command from Napoli* (Italy), able to conduct operations from their static locations or provide a land-based Combined Joint Task Force (CJTF) headquarters and a robust but more limited standing Joint Headquarters (JHQ), in Lisbon, Portugal, from where a deployable sea-based CJTF HQ capability can be drawn.

Both joint command Brunssum, and Naples operate commands specific to each component of forces in the party. They are considered at the tactical level: *CC-Air HQ* – Component Command Air Headquarters, *CC-Land HQ* – Component Command Land Headquarters, *CC-Maritime HQ* – Component Command Maritime Headquarters.

Thus, the five existing regional operational commands have been reduced to only two *Joint Force Commands* and a limited *Joint Force Command*, and their subordinated 13 operational commands have been reduced to six, meaning a total reduction of 20 commands to 11.

5. Addressing the transformation’s approach

This transformation is necessary to fully bridge the differences between physical, conceptual and actional from two different eras on conducting

wars. During the Cold War, the Alliance was primarily concerned with ensuring that the number of soldiers and means of combat and fire power necessary to the preparation and carrying out a war of attrition with any enemy from the East.

The large, Alliance’s forces were designed to provide the framework for organizing effective defense of the territory of Member States in case of threats, triggered by actions based on collective defence plans prepared long before. This attitude was a *reactive*, and since then, the Alliance has set as its objective the ability to act *pro-actively*.

NATO’s contribution to peace and stability has, in addition to military capabilities, a very wide range of policy initiatives and non-military ways, but if all these function, the specific Alliance’s value is closely related to the ability to implement consultations of the partnerships and political agreements in military action.

Therefore, to act *pro-actively* does not mean, however, always quickly to resort to force. Of a particular importance are the natures of agility and expeditionary forces in character and which can primarily contribute to the prevention or deterrence of conflict situations in a course of deterioration. The presence of forces, for example, during a humanitarian crisis, could help stabilizing the situation prior to escalation and might even contribute to creating conditions for a political solution prior to produce victims or material damages.

Many of the transformations that the Alliance has initiated efforts were aware that it has made to increase operational effectiveness. It is also the case of creating *Combined Joint Task Forces* in consequently the *Joint Operations*.

Thus, the Standing NATO seeks to improve its ability to conduct both current operations and the future.

The military requirements of the new operations of the Alliance have created pressure on force transformation. In response, principles as flexibility, deployment, sustainability, decision-making and technological superiority, effectiveness and, most importantly, interoperability have become the cornerstones of NATO’s relevance as a security organization.

A new system of forces, which was designed to satisfy the ambitions Alliance has been implemented, is characterized by: deployable forces and regional forces or NATO *Forces Command*,



which are under the operational command and operational control still on for peace; *NATO Forces* for action under NATO, and for future action under NATO command¹⁵. To conduct these operations, NATO uses organizational models: the joint force packages of forces, forces tailored to the needs of the operation).

To ensure the success of these new missions, NATO recognizes that it must adopt new ways of thinking, and that military means and procedures must include the use of coordinated and mutually beneficial tools for economic, political and military power of the allied nations, in order to achieve the desired effects the objectives identified.

Therefore, NATO's transformation is not confined only to new weapons systems and most modern equipment, but represents a new way to improve the way of action, it is the starting point for the Allied Command Transformation – ACT in developing the concept EBAO – *Effects Based Approach to Operations*.¹⁶

In the traditional sense, *effects-based operations* is not a novelty, but new types of effects-based operations aimed something else. High technology, information dominance and strategic initiative allow centred operations not only on manoeuvres but from the beginning, from the planning stage, on complex effects, irradiated and chained. The effects considered are the ones who put the enemy in a situation where they can not either retort, or protect the forces and means, not able to regenerate force in time.

Transformation is a continuous process, not a final state. But the need for continuing change is also generated by the fact that NATO still has to make sufficient progress in improving various components of operational effectiveness, following the spectrum value: national components *coordinating*, full forces *integrating* and *coherence*, including capacity non-military based effects, ranging cooperation network and interdependence.

Major General Frank H.J. Hye, former representative for Europe of the Allied Command Transformation, estimated, in 2006, that was certainly achieved the stage of *coordination* and that Allied forces were focused on tracking the state. Also, he stated that the best vehicle to allow the Alliance to reach and exceed the state is the *integration* of Reaction Force of NATO (NRF - NATO Response Force).

The last stage is described by a force able to conduct operations based on the effects brought into the network and interdependent – a coherent force.

ACT is an organization conceived by NATO nations and uniquely designed to be sustainable in order to explore, develop and apply the military transformation within the Alliance. ACT is *leading agent* for Alliance military transformation. ACT is the impulse that NATO nations and States to transform its forces, methods and organization so as to cope with the needs of the Alliance of century XXI century.

We can conclude with a quote from the Strategy for Transforming the Romanian Armed Forces in 2007, which stresses out that “*the engine of transformation is that the changes occurring in society, the transition from the industrial era to the era of information, changes in the war and asymmetric threats. [...] Military transformation is a continuous process of development and integration of new concepts, strategies, doctrines and capabilities in order to improve the forces' effectiveness and interoperability and adapt the Alliance to the new security context in a continuing shift that highlights the need for reassessing the military factor as the main source of credibility. This requires changes to the doctrine, organization and force structures, capabilities, business intelligence, training, education and procurement, personnel management and programming based programs, which are the main fields of application processing*”¹⁷.

NOTES:

¹ See, *NATO Handbook* of NATO Office of Information and Press, Bruxelles, 2001, p. 26.

² Conference on Security and Co-operation in Europe, renamed Organization for Security and Co-operation in Europe (OSCE) in 01 January 1995.

³ Teodor FRUNZETI, **Globalizarea securității**, București, Editura Militară, 2006, p. 194 .

⁴ *The Alliance's Strategic Concept* agreed by the Heads of State and Government participating in the meeting of the North Atlantic Council (Rome, 8 November 1991), in România – NATO, Negocierea și ratificarea Protocolului de aderare, Vol.2, Ploiești, Editura Printeuro, 2005, p.531.

⁵ Teodor FRUNZETI, **op. cit.**, p.194.

⁶ Henning RIECKE, The need for change, in „NATO Review”, Nr.1 spring, 2005, <http://www.nato.int/docu/>



review/2005/issue1/english/art2.html.

⁷ Ibidem

⁸ <http://dexonline.ro>

⁹ Apud, John GARSTKA, *The transformation challenge*, in „NATO Review”, Nr.1 Spring, 2005, <http://www.nato.int/docu/review/2005/issue1/english/special.html>.

¹⁰ Emil MARE, *Managementul schimbării în organizații*, in „Buletinul Universității Naționale de Apărare”, Nr.2, 2006, București, Editura Universității Naționale de Apărare, p. 140.

¹¹ *NATO Handbook*, Brussels, NATO Office of Information and Press, 2001, pdf, p. 43.

¹² Institute for National Strategic Studies, *Allied Command Structures in the New NATO*, Washington DC, National Defense University Press Publications, 1997, p. 10.

¹³ Details in: Institute for National Strategic Studies,

Allied Command Structures in the New NATO, Washington DC, National Defense University Press Publications, 1997, pp. 13-21 și *NATO Transformed*, Brussels, NATO Public, Diplomacy Division, 2004, p.12.

¹⁴ *Prague Summit Declaration* Issued by the Heads of State and Government participating in the meeting of the North Atlantic Council in Prague on 21 November 2002, Paragraph 4b, on <http://www.nato.int/docu/pr/2002/p02-127e.htm>.

¹⁵ Statul Major General, *Doctrina pentru Operații Întreprinse Multinaționale*, București, 2001, p 35.

¹⁶ Frank H.G. NYE, *A înțelege transformarea militară a NATO*, in „Impact Strategic” Bucharest, No. 3, 2006, Editura Universității Naționale de Apărare, pp.45-46.

¹⁷ *Strategia de transformare a Armatei României*, Bucharest, 2007, p.7.

Captain Aurelian RAȚIU (aurelian_ratiu@yahoo.com) is Assistant Professor in the Department of Management and Military Sciences at “Nicolae Bălcescu” Land Forces Academy, Sibiu. He has a Master Degree in Diplomacy and Foreign Affairs in International Relations and he is a PhD candidate at National Defence University “Carol I”, Bucharest.

ABOUT THE COUP D'ÉTAT AND THE DEFENCE AGAINST IT



The volume *About coup d'état and the defence against it*, signed by Victor Strîmbeanu, PhD (Risoprint Publishing House, Cluj-Napoca, 2009, 238 pages), has the merit of bringing into attention the coup d'état, the nature of the phenomenon, its origins, its evolution, the involved forces and its finalities, starting from the premises that you cannot protect yourself against something you are not familiar with.

The modern state, in the nowadays form, has appeared and crystallized as a historical need in a certain area and in a certain period of time within the evolution of the humankind. If there is almost an unanimous accepted consensus regarding the beginning of the state, the opinions are different when it comes to its end, determining the author, starting from the *Introduction*, to express a series of trenchant interrogations related with the state: Where is it now, in its evolution, for the time being? How far or how close is the end of the classical state, in the form we are familiar with nowadays? Is there still a need for the state? Has the humankind come to such a level of development that it cannot give up the state's prerogatives? Or can these prerogatives be transferred to other forms of social organization, without the risk of loosing the peoples' fundamental rights?

Structured in nine chapters (*The monograph of the coup d'état; The vectors of the coup d'état; The Secret Services (information) within the coup d'état; The Armed Forces within the coup d'état; Mass-media within the coup d'état; The population within the coup d'état; The Masonic structures within the coup d'état; Other organizations within the coup d'état; The defence against the coup d'état*), the volume tries coming closer to the standard specific to a handbook or treaty, by a high level of abstractization and generalization, avoiding purposely the references to the examples within history.

For the same reasons, for detaching from particular and general, every chapter ends with a mention regarding the month, the year and the place where it has been written, indirectly trying to suggest the universal, detached, independently nature, without considering a certain country, political regime or historical era.

The basic merit of the paper is that the analysis methodology used by the author determines a better knowledge and understanding of the contemporary phenomenon, some conceptual clarifications, launching a challenge for the academics and analysts on motivations, symptoms, conditions, forces, stages, and dynamics of the coup d'état, presenting the last evolutions in national and international area, the context provided by globalization, the reconfiguration of the internal forces (private police, "corporate security structures"), military's restructure and readjustments, the evolution of the state's functions, etc.

The analysis of the volume *About coup d'état and the defence against it* – an original scientific effort -, is intended to be a sufficient motivation for the interested reader.



THE ACTIVITIES OF THE CENTRE FOR DEFENCE AND SECURITY STRATEGIC STUDIES

OCTOBER - DECEMBER 2009

The 4th semester of the year was full of important scientific activities for the researchers of Centre for Security and Strategic Studies. The main of these was the Annual scientific communication session with international participation „Perspectives of security and defence in Europe”, undergone on November, 19th – 20th, to the Military Palace. There were sustained communications by foreign (Luxembourg, Ukraine, the Moldavian Republic) and Romanian scientific researchers and teachers from civil and military institutions.

Into the activity's framework were debated issues regarding the security process into the global crisis conditions, the influence of the space field in European security and defence, the importance of the security institutions into a changing world, provocations for defence and Romanian Military between defence and new missions. The event was co-organized by the Military Sciences Section of the Romanian Researchers Academy.

The researchers from Centre for Defence and Security Strategic Studies attended to diverse scientific activities from country and abroad. In November, to Rome, Italy, the chief of Studies and Researches section participated with a paperwork “Synergies to Mediterranean Sea and Pontus Euxinus” to the “Mediterranean area: different perspectives, common objectives” Conference, organized by The Italian Centre for High Defence Studies (CASD). One of conference's conclusions was that the problematic of Mediterranean Sea is strongly related by the Black Sea one.

In this time, the Centre published the study called: „The influence of the economic factor in security's accomplishment”.

As every year, also in 2010, the Centre will be involved in the organization of the XXI STRATEGIES Annual Scientific communication session under the theme: “The European security into the economic crisis context”, Security and Defence section, held in April, 15th – 16th. Information about the subscription conditions will be published on <http://cssas.unap.ro>. Details about the Centre's activities from 2010, the seminar organized in May and the Xth scientific communication session with international participation will be also announced on CDSSS site.

Irina CUCU



INSTRUCTIONS FOR AUTHORS

On selecting the articles there are taken into consideration: the area of the subjects presented in the magazine, the actuality of the topic, its novelty and originality, its scientific content and the adequacy to the editorial norms adopted by the magazine. The article should not contain any party political connotations.

The papers' scientific evaluation is done by two scientific experts that are either professors or senior fellow researchers.

The article, written in a foreign language (English, French) may have maximum 10-12 pages (6.000 – 7.000 words) and has to be sent both in print and paper, using Times New Roman font, size 12, one line, and the tables and schemes have to be printed separately. The translation into Romanian will be provided by the editor.

The text has to be preceded by an abstract which is not to exceed 250 words, both in Romanian and English and not more than 10-12 keywords. The papers have to be signed adding the authors's scientific degree, name, first name, the institution he comes from and have to end with a curriculum vitae, which should include the following elements: a short bio, a list of personal papers, birthyear, birthplace, address, city, postal code, country, telephone, fax, e-mail address, photo in jpeg format.

The footnotes are to be included by the end of the article and have to respect the international regulations. Authors can publish only one article by issue.

The text has to present an easy structure, using titles (subtitles). The abbreviations will be marked on the text only at their first mention on the text. It is likely to end the papers with some important conclusions regarding the importance of the research.

The articles will not use classified information.

As the magazine does not have a profitable purpose, the articles cannot be paid.

Our address is: National Defence University "Carol I", the Centre for Defence and Security Strategic Studies, 68-72 Panduri Street, sector 5, Bucharest, Romania, telephone: (021) 319.56.49; Fax: (021) 319.55.93, e-mail: cssas@unap.ro, web address: <http://cssas.unap.ro>, <http://impactstrategic.unap.ro>



After eight years since its first edition, STRATEGIC IMPACT magazine, edited by the Centre for Defence and Security Strategic Studies from the National Defence University “Carol I” is a quarterly scientific magazine acknowledged locally and internationally for the wide area of topics - the political-military present, security strategy and military security, NATO and EU actions, informational society, strategic synthesis and evaluations, a special column “Strategic Event” that studies the strategic impact of the dynamics of the actions undertaken nationally, regionally and globally.

STRATEGIC IMPACT has as collaborators important researchers and personalities within the scientific research area and from the civilian and military university system, both national and international, from the Ministry of National Defence, General Staff, services’ staffs, the Ministry of Administration and Interior, Ministry of Foreign Affairs, military units and other state’s organizations, NGOs, companies, etc.

The international acknowledgement of the magazine’s quality is confirmed by its editions presented on sites belonging to prestigious foreign institutions (Defence Guide, in collaboration with the Hellenic Institute of Strategic Studies – HEL.I.S.S.), The Institute for Development and Social Initiatives – IDIS from the Republic of Moldova – the virtual library for political and security studies. Also, the magazine is included in international databases: CEEOL - Central and Eastern European Online Library, Germany, IndexCopernicus International, Poland.

The magazine is accredited by the National University Research Council and acknowledged as a B+ magazine that demonstrates the potential to become an international acknowledged magazine.

STRATEGIC IMPACT is a representative forum for reflection and debates on topics related to strategy and security for the scientific, academic, national and international community.

At present, STRATEGIC IMPACT magazine is issued separately in two editions, Romanian and English, and disseminated in the domestic and international scientific environment and also to the main institutions involved in security and defence.

Issue organizer: Corina VLADU
Designer: Corina VLADU
Masterproof: Corina VLADU
The National Defence University “Carol I” Printing House
